

2010 GUIDE TO TOWING

A Supplement to **TRAILER**
LIFE



HUNDREDS OF LISTINGS!

PLUS

- SELECTING A TOW VEHICLE
- HITCH TYPES & MAINTENANCE
- TRAILER-BRAKE CONTROLS
- TIPS ON SAFE TOWING

MAN, TRAILERS ARE LIKE
**WILD
ANIMALS.**

**They're always trying
to get away from you.
Until now. Trailer sway control, standard.**





FORD F-150

FIND OUT MORE AT **FORDVEHICLES.COM**



Ford Motor Company, go to www.trailerlife.com/info

2010 GUIDE TO TOWING

CONTENTS

- 5 Selecting a Tow Vehicle**
Choosing the tow vehicle that works best for your needs requires careful consideration of weights and measures
- 10 Towing 2010**
Ford introduces RV-friendly Super Duty features, while all manufacturers focus on improving fuel economy
- 14 How to Use This Guide**
- 15 2010 Tow Ratings Guide**
- 28 Hitching Up**
Examining the various types of hitches, their uses and maintenance techniques
- 33 Trailer-Brake Control**
Latest technology improves safety, reliability and stopping power
- 36 What's in a Towing Package?**
There's much more to it than a hitch ball and electrical umbilical cord
- 40 Ready for the Road**
Plenty of patience, practice and defensive driving will lead to a pleasant towing experience

TRAILER LIFE

EDITORIAL PUBLISHER
BOB LIVINGSTON

EDITOR
KRISTOPHER BUNKER

MANAGING EDITOR

MARLEEN CANNIFF

CREATIVE ART DIRECTOR
MIRANTE ALMAZAN

EDITORIAL/BUSINESS OFFICE
2575 VISTA DEL MAR DRIVE, VENTURA, CA 93001
■ TEL. (805) 667-4100 ■ FAX (805) 667-4484

ADVERTISING VP/NATIONAL SALES
VENTURA, CALIFORNIA
TERRY THOMPSON

BUSINESS MANAGER
DENIELLE STERNBURG

P.O. Box 8510, VENTURA, CA 93002
■ TEL. (805) 295-7820 ■ FAX (805) 667-4379

Elkhart, Indiana
MIDWEST SALES DIRECTOR
CHUCK LASLEY

NATIONAL ADVERTISING SALES
TACY HENDERSHOT

NATIONAL ADVERTISING SALES
LOU CIORELLI

2300 MIDDLEBURY STREET, ELKHART, IN 46516
■ TEL. (574) 295-7820 ■ FAX (574) 522-0418

Seattle, Washington
NATIONAL ADVERTISING SALES
SCOTT OAKES, JOHN MARGIANO

1818 WESTLAKE AVENUE N, #420
SEATTLE, WA 98109
■ TEL. (206) 283-9545 ■ FAX (206) 283-9571

Detroit, Michigan
CROMPTON HOLDINGS
SCOTT CROMPTON
2031 FERNWAY DRIVE
MONTGOMERY, AL 36111

■ TEL. (334) 613-2040 ■ FAX (334) 356-7740

TRAILER LIFE IS A REGISTERED TRADEMARK OF AFFINITY GROUP INC. COPYRIGHT 2010 BY AFFINITY GROUP INC. ALL RIGHTS RESERVED. TRAILER LIFE (USPS #454-970) IS PUBLISHED MONTHLY BY AFFINITY GROUP INC. SUBSCRIPTION PRICE, U.S. AND POSSESSIONS: 1 YEAR, \$15.97; 2 YEARS, \$27.97. ALL OTHER COUNTRIES, ADD \$12 PER YEAR.

FOR MORE INFORMATION, VISIT OUR WEB SITE AT
www.trailerlife.com

2010 Guide to Towing Sponsors

Ford Motor Company
(800) 392-3673
www.ford.com

Hensley Manufacturing Inc.
(800) 410-6580
www.hensleymfg.com

SELECTING A TOW VEHICLE

Heeding the manufacturer's tow ratings is necessary to make appropriate model and option choices

BY DUNCAN O'NEAL

With so many choices available in tow vehicles, selecting the one that works best for your application may seem like a daunting task. There are many variables to consider, including budget, brand and towing capacity, and it's important to examine them all carefully before making a purchase. Going through the effort to better understand each variable and to account for all of them up front will lead to a more pleasant trailering experience later.

Weight Matters

The tow-ratings guide in this section lists the maximum tow ratings for vehicles with specific equipment, but many buyers interpret the maximum vehicles' tow ratings with far too much optimism. Always check the manufacturer's figures before making a purchase. The following is an explanation of the terms you need to know which, when combined with readings from a public scale and from your own calculator, should help you determine the correct tow



2010 **TRAILER LIFE** Towing Guide | 5

rating for the tow vehicle you plan to buy.

Gross Combination Weight Rating (gcwr):

The total allowable weight of the tow vehicle, the trailer, the cargo in each, fluids and occupants.

Gross Vehicle Weight Rating (gvwr): The total allowable weight for the vehicle, including fluids, options, hitch, cargo and trailer-hitch weight. The trailer's gvwr is the total allowable weight of the trailer, fluids, occupants, options and cargo.

Gross Axle Weight Rating (gawr): The total allowable weight on any given individual axle. This includes the weight of the tires, wheels, brakes and the axle itself.

Maximum Tow Rating: The manufacturer's weight limit for towed loads. For conventional trailers, this normally includes a hitch-weight limit as well; for fifth-wheels, the pin weight is applied to the truck's gvwr and its rear-axle gawr.

Trailer and Tow Rig Matchup



The gvwr and gawr for all motor vehicles are listed on the data plate, typically affixed to the driver's door frame, fuel door, glove box, end of the dashboard or other easy-to-access location. Brochures and window stickers may be inaccurate. All trailers should have a weight sticker — normally found in an interior cabinet — that lists the trailer's Unloaded Vehicle Weight (uvw), gvwr, weight added by fresh water and LP-gas and the resulting cargo carrying capacity (ccc).

In many cases, especially on older trailers, optional equipment — such as air-conditioning units, generators and the fuel they run on — sneaks onboard after weighing, and may not be reflected on the sticker. (And don't forget the fuel-fill tanks that some SURVs offer for campsite refueling of motorcycles and ATVs.)

Recreational Vehicle Industry Association (RVIA) weight label requirements are more inclusive of dealer-added options and make it much easier for buyers to have access to more

accurate weight figures.

The gvwr figures are neither guidelines nor estimates; they are limits, and there are numerous valid reasons the manufacturer arrived at the figures given. If you think these figures are “close enough” or have a fudge-factor percentage built in, think again. Your warranty coverage, and your safety, may be at risk.

The only sure-fire way to find out what your trailer weighs is to load it as usual for a trip and weigh it at a public scale. Without forming a long line of commercial trucks waiting their turns at the scale, get the hitch weight, axle weight and total weight. Assuming that the axle weight is below the gawr, the total is below the gvwr and the hitch weight is below the maximum given for your tow vehicle, you can then move on to tow-vehicle selection.

When purchasing a trailer, consult the weight sticker on the unit of your choice on a dealer's lot and refer to the uvw and ccc.

Estimate how much cargo you will add, being mindful of the gvwr, and use that number while selecting a tow vehicle.

To a lesser extent, tow-vehicle weight is variable as well. Brochures and tow guides frequently list how much a tow vehicle weighs, but this number generally applies to the most basic model in that configuration, without any options. In some cases, distinctions are made by engine, transmission, drive system (2WD or 4WD/AWD) and, in other cases, by cab or bed styles. If the dealer does not have a vehicle equipped as you want that is available to weigh, or cannot provide option weights, you can form rough estimates — but exact figures are the only way to be certain.

Bigger engines add weight, diesels more so because they come with additional accessories (up to 700 pounds more than the standard gas engine is common). Add up to 175 pounds for an optional transmission, about 400 pounds for 4WD and a bit less than 300 pounds for longer beds. Then add other options like luxury-trim levels, as all those electric motors add up. The towing package and hitch could add another 100 pounds, and larger wheels and tires can also have an effect.

Following is how to calculate the realistic towing capacity of the vehicle that interests you.

For example, consider a fictional one-ton longbed, diesel, extended-cab, 2WD, single-rear-wheel pickup set up for towing. We'll arbitrarily assign it a gvwr of 9,900 pounds, a front gawr of 5,000 pounds, a rear gawr of 6,824 pounds, a gcwr of 23,000 pounds and a quoted maximum tow rating of 17,000 pounds.

As is often the case in single-rear-wheel

trucks, the rear axle's gawr on this truck is derived from each tire's maximum load of 3,412 pounds. Pickups such as this normally start at more than 6,000 pounds, and with a diesel, automatic and nice trim, figure that with a full tank of fuel and hitch, this unit weighs 7,000 pounds. If we add two "standard-size" people (154 pounds each), a few tools and some cargo, it weighs 7,500 pounds. That is split to 4,000 pounds on the front axle, and 3,500 pounds on the rear axle.

The first thing you should have noticed is that the maximum tow rating cannot apply with the truck fully loaded because gcwr (23,000) minus gwvr (9,900) leaves 13,100 pounds — about 4,000 pounds less than quoted towing ability. After adding options and people to the example truck, and subtracting that value (7,500) from gcwr (23,000), the effective working tow rating of the truck becomes 15,500 pounds, about 1,500 pounds less than the truck's quoted maximum towing rating.

However, you have yet to check all the numbers and verify that a 15,500-pound trailer will work. If that trailer is a fifth-wheel and has 20 percent of its weight on the pin, that adds 3,100 pounds to the back of the truck. This would make the truck overweight — its 7,500-pound ready-to-roll weight plus the 3,100 pounds on the pin equals 10,600 pounds — 700 pounds

more than the truck's gwvr, and just 224 pounds shy of the rear-axle limit of 6,824 pounds.

SUVs and other non-pickup tow rigs cannot escape scrutiny. The vehicle's loaded weight, with the anticipated load of passengers aboard, must be subtracted from the gcwr to determine the realistic tow rating.

Other Factors to Consider

The tow-ratings chart lists vehicle-towing maximums segregated by engine, cab style, drive and single- or dual-rear wheels as appropriate. In general, assume the maximum tow rating always requires a towing package — and special towing equipment (see "What's In a Towing Package" on page 36) — and the highest numerical axle ratio offered, and as the example shows, maximums can be confusing. You can do your own estimates by starting with the information given and keeping the following generalizations in mind.

Transmission: For the majority of vehicles, automatic transmissions offer the higher tow ratings when they vary by transmission. On heavy-duty (HD) models, the difference may be 1,000 pounds or less, and on lighter-duty vehicles, a manual tranny might rate a 2,000-pound lower tow rating. Exceptions include high-output engines that are available only with manual gearboxes, vehicles where the manual



2010 **TRAILER LIFE** Towing Guide | 7

transmission weighs more than the automatic and transmissions in vehicles designed for high performance and not towing.

Axle Ratio: Lower gearing (the numerically higher ratios, e.g. 4.10:1, 4.56:1, as opposed to 3.55:1, 3.73:1), typically produces greater tow ratings because of greater torque multiplication. There is a wide variance in the axle ratio's effect on the tow rating, with some diesel-powered pickups varying only a few hundred pounds. On others, changing from a 3.73:1 to a 4.30:1 sometimes increases the tow rating by 3,500 pounds. In the past, some ratings have increased by a factor greater than three (from 2,000 to 7,100 pounds) simply by using a different axle ratio. Lower gearing will also make your vehicle accelerate quicker up to 50-55 mph. In general, a one-step drop in axle ratio (4.10:1 to 3.73:1) on an HD pickup will drop tow rating and gcwr by a ton.

Lower gearing has an adverse effect on fuel economy, but it's usually not proportional to the gain in towing ability. Under the best circumstances, the difference between the highest and lowest gear ratios offered (say, 3.42:1 and 4.10:1) results in a 1.5-mpg decrease in non-towing, steady state-highway cruising. In most conditions that change is less than 1 mpg, and if you tow a relatively heavy trailer a lot, there's no question that the lowest gearing is best.

Drive System: Vehicles that drive only two wheels, be they front or rear, generally have higher tow ratings (all other things being equal). Even though modern 4WD and AWD systems are quite efficient, a small amount of parasitic loss uses up energy. More importantly, 4WD systems add weight — easily up to 400 pounds on some HD pickups — and that weight frequently comes off the tow rating. Unless the gcwr and gvw are higher, a 4WD version will probably tow a few hundred pounds less than its 2WD counterpart.

Towing Package: If you can order a towing package, do so. Not only is it usually required to get the top tow rating, but the contents rarely can be duplicated for the original cost — and it will add to resale value. You can plainly see the hitch receiver or electrical receptacle, but there are often other changes to the wiring system (including up-rated wire and fuses), alternator, battery, cooling system, power steering and lubricants.

Bed Length/Style: If there's a difference, a longbed truck may rate slightly lower in tow capacity — about 150-250 pounds — because the longer bed adds weight. In other cases there is no change because the longer wheelbase is beneficial. Note that the more "styled" beds marketed under a variety of names typically are heavier than conventional slab-sided beds, and



that cab-and-chassis figures do not reflect any bed unless otherwise noted. A steel bed for a medium-duty cab-and-chassis could quickly eat up an entire ton of its gcwr.

Single or Dual Rear Wheels: Most people assume that a dually pickup will have a higher tow rating than a single-rear wheel unit, but this is not always so. In many cases the gcwr is limited by factors other than the number of rear wheels and does not change, and in those cases the weight of the wider axle, bigger brakes and two more tires and wheels is subtracted from the gcwr. The dually no doubt provides a more stable towing platform for the heavier trailers, although not always with the highest tow rating. A dually will have a higher gvwr because the dual-wheel rear axle might have a 10,000-pound gawr, for example, compared to the single-rear-wheel truck's 6,824-pound gawr. Gawr is not always an exact calculation of the tire capacity times the number of tires. A dually-equipped truck will be better for hauling a heavy slide-in truck camper and handling heavy fifth-wheel pin weights because of the weight concentrated on the rear axle as compared to the average trailer's hitch weight.

Tires: Wheel sizes continue to grow commensurate with their popularity, with some tow vehicles offering 20-inch wheels as factory options. However, using a larger wheel and lower-

profile tire means a smaller air cushion and lower tire sidewall, to the extent that tow ratings generally drop whenever the wheel size increases — and ride comfort can be compromised. Read the fine print on the packaging carefully.

Practical Application

Before purchasing any vehicle for towing, ensure that the equipment required is available for your vehicle. You may find that the new-kid-on-the-block is a very capable tow vehicle, but no one makes a fifth-wheel hitch for it. Ford has remedied this quandary with an optional factory-installed fifth-wheel saddle on 2011 Super Duty trucks, but other manufacturers have not. Also beware of hitch-ball and receiver ratings, as some trucks are rated for heavier loads than any easily found hardware can handle, and therefore may require special-order parts. Also keep in mind that the powertrains used in some vehicles may not be available in each of the 50 states or Canada.

Before purchasing a vehicle, we suggest you acquire the manufacturer's comprehensive towing guide, available online or at dealerships. Be sure to read the fine print because in many cases the maximum rating may apply only to one particular version and be for a fifth-wheel trailer; many larger pickups may have their actual tow rating limited by the hitch and hardware. 🚚



TOWING 2010

Ford to debut 2011 Super Duty, while all manufacturers look to a brighter future with exciting and capable tow vehicles

BY CHRIS HEMER

It's no secret that automobile manufacturers have experienced their slowest sales in more than 20 years. With this in mind, you might expect the Big Three and top import manufacturers to play it safe, with just minor revisions and color changes for 2010. Nothing could be further from the truth. Both Dodge and Ford are introducing completely revised heavy-duty trucks for 2010 (and 2011), and GM has also made significant changes to its lineup.

Fuel economy is a hot topic this year, and many manufacturers offer their products with tall (numerically lower) rear-axle ratios to get the best possible highway mileage (especially in full-size pickups and SUVs). If maximum towing capacity is your goal, check with your dealer to make sure your vehicle is properly equipped for the task at hand.

Here are some of the new vehicles for 2010:

Ford Motor Company

Fifth-wheel RVers rejoice! Ford has finally unveiled its 2011 Super Duty — complete with a first-ever factory-installed fifth-wheel-hitch option. The factory-warranty-covered hitch is bolted directly to the frame, and the electrical connection is mounted on the side of the bed wall, eliminating potential aftermarket

headaches and keeping the installation clean.

Though the 2011s aren't radically different in appearance from the outgoing 2010 models (which are essentially carry-over), the 2011 Super Duty boasts an all-new powertrain, including a 6.7-liter Power Stroke turbo diesel. This engine, which was engineered and built by Ford this time around, promises improved torque and horsepower, as well as significantly improved fuel economy and reduced NVH (noise, vibration, harshness). Several new technologies make their debut on this engine, including a compacted graphite iron (CGI) block (Ford claims that this material is both lighter and stronger than cast iron); inboard exhaust and outboard intake architecture, and a Honeywell VNT (Variable Nozzle Turbine) DualBoost turbocharger featuring a dual-sided compressor wheel that reportedly delivers the benefits of a twin turbo system. The engine also utilizes aluminum cylinder heads instead of cast iron, and features a high-pressure Bosch fuel system that delivers fuel at 29,000 psi. Also of note is that the new engine will no longer require the cab to be removed for some service procedures, dramatically cutting down on labor costs and down time. New to the lineup is a 6.2-liter SOHC gas V-8 with roller rocker



10 | 2010 TRAILER LIFE Towing Guide



Ford F-250 Super Duty



Ford Flex



Ford F-150 SVT Raptor



Lincoln MKT

shafts, variable cam timing, two plugs per cylinder and dual knock sensors. Both engines are backed by a new TorqShift six-speed automatic transmission with enhanced Tow/Haul mode, integrated exhaust engine braking, SelectShift Automatic capability, and Live Drive PTO (Power Take Off).

Ford's 2010 Super Duty trucks are essentially carry-over from '09, save for a factory spray-in bedliner option.

Betting on the perennial success of its F-150 pickup, Ford has also invested in an all-new model: the F-150 SVT Raptor. Like other SVT products, the Raptor is a special, high-performance model. But unlike its predecessors, the Raptor is focused on off-road use. A body that is more than 7 inches wider than a standard F-150 accommodates the purpose-built suspension, which includes a new front axle, upper/

lower A-arms, tie rods, half-shaft joints and internal triple bypass shocks by FOX Racing Shox — an industry first on a production truck.

Rolling on SVT-spec 35-inch BFGoodrich (BFG) tires, the Raptor comes standard with a host of useful technologies, such as Advance-Trac (traction control) with Roll Stability Control, Trailer Sway Control, an integrated trailer-brake controller, tow/haul mode, Hill Descent Control and Off Road Mode, which utilizes a special throttle map and shift schedule. The Raptor will launch with the 5.4-liter Triton V-8 with 320 hp, and later will be available with the new 6.2-liter V-8 producing an estimated 400 hp and 400 lb-ft of torque. Both engines are backed by a six-speed automatic transmission and are capable of towing up to 6,000 pounds. The Raptor will be easily recognizable, thanks to its fender



flares, “digital mud” graphics, cast-aluminum running boards and unique “brick wall” grill.

The Ford Flex is now offered with a 3.5-liter EcoBoost V-6 engine that delivers 355 hp and 350 lb-ft of torque. The all-wheel-drive model gets 16 mpg city and 22 mpg highway, the same as the base all-wheel-drive Flex. Active Park Assist, a paddle-shift six-speed automatic transmission, a 4,500-pound tow capacity and standard Trailer Sway Control are other useful additions.

The Lincoln MKT is all-new for this year, and is a luxury variant of the Flex. Offered with either a 268-hp 3.7-liter V-6 or the 355-hp 3.5-liter EcoBoost, the MKT is loaded with convenience and luxury features such as a Panoramic Vista Roof, six or seven-passenger seating, adaptive cruise control, adaptive headlamps, rain-sensing wipers, blind-spot information system, a reverse camera system, Lincoln SYNC and an available Navigation Package.

Chrysler/Dodge/Jeep



Jeep Grand Cherokee



Dodge Ram Crew Cab

The big news from the Pentastar people is the new Dodge Ram Heavy Duty pickup series. Borrowing many styling cues from the newly revised 1500 series light-duty trucks, the new 2500 and 3500 HD trucks will be available for the first time with a true Crew Cab. You may recall that Quad Cab models have smaller rear doors, while the Mega Cab is the stretch limo of the truck world. The new Dodge Crew Cab will replace the Quad Cab, but regular and Mega Cab models will remain. Two cargo box sizes (6-foot 4-inch and 8-foot) and single/dual rear wheel configurations will be offered.

The venerable 6.7-liter Cummins I-6 turbo-diesel soldiers on with a choice of either a G56 six-speed manual transmission with ultra-low first gear, or a 68RFE six-speed automatic and a standard exhaust brake. The base 5.7-liter

Hemi gasoline V-8 gets several improvements, including variable valve timing, higher compression, an “active” intake manifold (variable intake runners) improved cylinder heads and free-flowing exhaust. It is backed by a five-speed automatic transmission with Electronic Range Select and tow/haul mode. Moreover, the HD models will boast an integrated trailer brake control, improved suspension, an available tow rating of 18,500 pounds, and a gross combined weight rating (gcwr) of up to 25,400 pounds.

The Ram Power Wagon also makes its return, armed with electric locking differentials, electronic disconnecting sway bar (for improved suspension articulation off road), Bilstein shocks, 32-inch BFG tires, skid plate, an available 4.56:1 axle ratio and a custom-built 12,000-pound Warn winch.

The Dodge 3500/4500/5500 Chassis Cab story is a strange one for this year; the 2010 models are essentially carry-over from 2009, and still offer that year’s cab configurations (i.e. Quad Cab). But in a few months, the 2011 models will arrive, sporting the new Crew Cab, new exterior styling and several other revisions. Among these are the integrated trailer brake controller, standard diesel exhaust brake, six-speed manual or automatic transmission with Power Take Off (PTO) capability and a standard (diesel) gcwr of 24,000 pounds. The proven 6.7-liter Dodge-Cummins engine and revised 5.7-liter Hemi gas V-8 are the engine offerings.

Chrysler’s Jeep division has also released details on the all-new 2011 Jeep Grand Cherokee, billed as the “sweet spot of real-world capability and on-road refinement.” To help achieve this goal, the 2011 Grand Cherokee will be equipped with a Quadra Lift air-suspension system that provides height control and lifts the vehicle 4½ inches for a maximum ride height of 11 inches. Three four-wheel-drive systems, a new Selec-Terrain with five terrain settings and a new flexible fuel 3.6-liter V-6 with variable valve timing (VVT) and 280 hp round out changes to the driveline. The 5.7-liter Hemi will remain, with VVT and 360 hp.

The Chrysler Aspen and Dodge Durango have been discontinued.

General Motors

Not surprisingly, there’s not a lot to report from the beleaguered General Motors, but there is some good news. The popular Chevy Equinox has been redesigned, and it now has a new sibling, the GMC Terrain. Both vehicles are powered by a new 2.4-liter direct-injected four cylinder that delivers a segment-best EPA fuel-economy rating of 32 mpg on the highway. An



Chevrolet Equinox



Chevrolet Silverado



GMC Terrain

available 3.0-liter direct-injected V-6 makes an impressive 264 hp, and both engines are mated to a six-speed automatic transmission. Available in front- or all-wheel drive, the Equinox and Terrain come standard with six airbags, four-wheel disc brakes, StabiliTrak stability control, traction control, OnStar and XM Satellite Radio.

The Silverado/Sierra 4.8-liter, 5.3-liter and 6.2-liter V-8 engines now have E85 FlexFuel capability, while variable valve timing on the smaller engines is designed to improve fuel economy. The 5.3-liter models also receive a super-tall 3.08:1 rear-axle ratio, fuel-saver mode and a six-speed automatic transmission with the regular or extended cab. Side curtain airbags, seat-mounted side-airbags, and StabiliTrak stability control are standard on all 1500 models. USB connectivity is also standard on all radios now except for the base model. There are no major changes to the HD pickup line this year.

Suburban/Yukon XL get flex fuel capability with the 6.0-liter V-8, and Tahoe/Yukon models with the 5.3-liter V-8 are also flex-fuel compatible. The Chevy Colorado/GMC Canyon offers a 5.3-liter V-8 with variable valve timing, as well as curtain and side-impact airbags.

Cadillac has jumped into the crossover fray with its new SRX. Though it shares styling cues with other products in the Cadillac family, the

SRX is an all-new design featuring a unique chassis and the smallest V-6 engines Cadillac offers in North America. It will be introduced with a 3.0-liter direct injected V-6 that delivers 265 hp, but a 2.8-liter turbo V-6 that churns out an estimated 300 hp will be available by mid-2010. Both engines are backed by a six-speed automatic transmission. The SRX is available in front-wheel drive, or with a new all-wheel-drive system featuring an electronic limited slip differential (ELSD). Developed in partnership with Haldex, the system can distribute power from the front to the rear axle, as well as from side to side across the rear axle, for the best possible traction.

The midsize Chevy Trailblazer and GMC Envoy as well as the medium duty Chevy Kodiak and GMC TopKick have been discontinued.

Toyota



Toyota 4Runner



Toyota Tundra

Toyota has a well-deserved reputation for continual improvement and, for 2010, that hasn't changed. The biggest news is a new 4Runner, which is more rugged and angular than the current model, and offers a choice of a 2.7-liter I-4 or a 4.0-liter V-6 with variable valve timing and 270 hp. Options such as crawl control, a dynamic suspension system, off-road ABS and water-repellent seats should put the 4Runner back in the good graces of off-road enthusiasts.

The FJ Cruiser will also get the updated 4.0-liter, and a new Special Edition model adds Bilstein shocks, skid plates, Toyota Racing Development (TRD) wheels with BFG tires and a rear differential lock. As is the trend with full-size trucks, the popular Tundra will wear a more massive grille, and the base 4.7-liter V-8 will be replaced with the aforementioned new 4.6-liter V-8 with 310 hp and a six-speed automatic transmission. Same goes for the Sequoia full-size SUV. 🚚

2010 **TRAILER LIFE** Towing Guide | 13

HOW TO USE THIS GUIDE

F-250/F-350/F-450 Super Duty, Fifth-Wheel Towing, Automatic Transmission			F-450 Crew Cab DRW 2WD	6.4L V-8 TD	24,600 (l,t)
F-250/F-350 Regular Cab SRW 2WD	5.4L V-8	10,200 (j)	F-450 Crew Cab DRW 4WD	6.4L V-8 TD	24,200 (l,t)
F-250/F-350 Regular Cab SRW 2WD	5.4L V-8	12,200 (k)	F-250/F-350/F-450 Super Duty, Fifth-Wheel Towing, Manual Transmission		
F-250/F-350 Regular Cab SRW 2WD	6.8L V-10	15,000 (k)	F-250/F-350 Reg. Cab SRW 2WD	5.4L V-8	9,200 (j)
F-250/F-350 Regular Cab SRW 2WD	6.8L V-10	16,500/16,900 (j)	F-250/F-350 Reg. Cab SRW 2WD	5.4L V-8	11,200 (k)
F-250/F-350 Regular Cab SRW 2WD	6.4L V-8 TD	16,300 (l/h)	F-250/F-350 Reg. Cab SRW 2WD	6.8L V-10	14,000 (k)
F-250/F-350 Regular Cab SRW 4WD	5.4L V-8	9,800 (j)	F-250/F-350 Reg. Cab SRW 2WD	6.8L V-10	16,000 (j)
F-250/F-350 Regular Cab SRW 4WD	5.4L V-8	11,800 (k)	F-250/F-350 Reg. Cab SRW 4WD	5.4L V-8	8,800 (j)
F-250/F-350 Regular Cab SRW 4WD	6.8L V-10	14,600 (k)	F-250/F-350 Reg. Cab SRW 4WD	5.4L V-8	10,800 (k)
F-250/F-350 Regular Cab SRW 4WD	6.8L V-10	16,100/16,500 (j)	F-250/F-350 Reg. Cab SRW 4WD	6.8L V-10	13,600 (k)
F-250/F-350 Regular Cab SRW 4WD	6.4L V-8 TD	15,800 (l/h)	F-250/F-350 Reg. Cab SRW 4WD	6.8L V-10	15,600 (j)
F-350 Regular Cab DRW 2WD	5.4L V-8	12,200 (k)	F-250/F-350 Reg. Cab SRW 4WD	6.4L V-8 TD	15,800 (h)
F-350 Regular Cab DRW 2WD	6.8L V-10	16,500 (k)	F-350 Reg. Cab DRW 4WD	6.4L V-8 TD	15,800 (v/k)
F-350 Regular Cab DRW 2WD	6.4 V-8 TD	16,300 (j)	F-250/F-350 SuperCab SRW 4WD	5.4L V-8	8,500 (j)
F-350 Regular Cab DRW 2WD	6.4 V-8 TD	18,800 (k,p)			

Tow ratings for all vehicle manufacturers are listed in alphabetical order and are organized by model type and configuration. Under each vehicle brand, you will find three headings: Vehicle, Engine and Tow Limit (lb). The vehicle heading describes the vehicle model and/or configuration, and indicates whether the vehicle is 2WD (front or rear), 4WD or All Wheel Drive (AWD). The engine heading shows the engine size expressed in liters, followed by the configuration (I = Inline, V = V engine as in V-6 or V-8) and the number of cylinders. Under tow limit, you will find the manufacturer's stated maximum tow capacity for that vehicle. In many instances, you may note a letter(s) and/or symbol(s) after the model or tow rating, which indicates a footnote listing specific requirements for that rating, such as a certain gear ratio. When letters or symbols are separated by a comma, this is an indicator that more than one footnote applies; when separated by a forward slash (/) either/or can apply.

A slash may also be used to separate two different models, if the ratings differ depending on how the vehicle is equipped. In these instances, ratings relative to the model or its equipment will be listed in respective order under the tow limit heading. Example:

Vehicle	Engine	Tow Limit (lb)
F-250/350 Regular Cab SRW 2WD	5.4L V-8	10,200(j)

In most instances, you will find a letter (or letters) which identify the equipment that rating is based on, i.e. automatic or manual transmission, gear ratio, towing package, etc. You will

find the meaning for each of these letters in the Trailer Life Key to Charts.

If there is no letter after the rating, that means there is only one rating available. Likewise, you may find the word "all" in the engine column; that means all available engines are capable of that particular tow rating.

We've also included pertinent factory notes where applicable about each vehicle or family of vehicles, but due to space considerations, we cannot possibly list all of them. When considering a certain vehicle for purchase based on its tow rating, make sure to consult with the dealer and/or manufacturer's towing guide to get specifics on what that tow rating is based upon. For example, many tow ratings are based on an unloaded vehicle with one occupant; if you normally travel with your family and equipment, you must deduct passenger/equipment weight accordingly to arrive at that vehicle's actual towing capacity in your application. Most trailer weights are based on the assumption that you will be using a weight-distributing hitch (and rightfully so), and have drastically reduced ratings for the same application using a weight-carrying hitch.

Finally, remember that every effort has been made to ensure the accuracy of this guide, but many of the ratings contained in it were considered "preliminary" by the manufacturer at the time this guide was published (which is before "official" ratings have been released in many cases). Most of the time, the numbers don't change when the official ratings are released but, in some instances, they do. Perhaps more importantly, the ratings don't usually change significantly enough to affect your purchase decision. 🚚

TRAILER LIFE

FOLLOW THE ROAD TO ADVENTURE

2010 TOW RATINGS GUIDE

COMPILED BY CHRIS HEMER

Key to Charts

a = Automatic Transmission

a4 = Automatic transmission, Four Speeds

a5 = Automatic transmission, Five Speeds

a6 = Automatic transmission, Six Speeds

b = 3.08:1

c = 3.15:1

d = 3.21:1

e = 3.23:1

f = 3.31:1

g = 3.42:1

h = 3.55:1

i = 3.73:1

j = 3.92:1

k = 4.10:1

l = 4.30:1

m = Manual Transmission

m5 = Manual Transmission, Five Speeds

m6 = Manual Transmission, Six Speeds

n = 4.44:1

o = 4.56:1

p = Cooling or other accessory package required

q = 4.88:1

r = 5.38:1

t = Towing package required

AWD = All Wheel Drive

CC = Crew Cab

KC = King Cab

SB = Short Bed

Std. Bed = Standard Bed

LB = Long Bed

SWB = Short Wheelbase

LWB = Long Wheelbase

DRW = Dual Rear Wheels

CV = Cargo Van

PV = Passenger Van

TD = Turbodiesel

TC = Turbocharged

SC = Supercharged

NA = Not applicable, or not available

Vehicle	Engine	Tow Limit (lb)
ACURA		
MDX	3.7L V-6	5,000
AUDI		
Q5	3.2L V-6	4,400
Q7	3.6L V-6	5,500
Q7	3.6L V-6	6,600 (t)
Q7	4.2L V-8	5,500
Q7	4.2L V-8	6,600 (t)
BMW		
X3 3.0i	3.0L I-6	3,500
X5 3.0si	3.0L I-6	6,000
X5 4.8Li	4.8L V-8	6,000
X535d	3.0 I-6 TD	6,000
X635i	3.0L I-6	6,000
X650i	4.4L V-8	6,000
BUICK		
Enclave FWD	3.6L V-6	2,000
Enclave FWD	3.6L V-6	4,500 (t)
CADILLAC		
Escalade 2WD	6.2L V-8	8,300
Escalade AWD	6.2L V-8	8,100
Escalade ESV 2WD	6.2L V-8	7,600
Escalade ESV AWD	6.2L V-8	7,800

Escalade EXT AWD	6.2L V-8	7,500
Escalade Two Mode Hybrid 2WD	6.0L V-8	5,800
Escalade Two Mode Hybrid 4WD	6.0L V-8	5,600
SRX AWD	2.8L V-6 TC	3,500
SRX AWD	3.0L V-6	2,500
SRX AWD	3.0L V-6	3,500 (t)
SRX FWD	3.0L V-6	2,500
SRX FWD	3.0L V-6	3,500 (t)

CHEVROLET/GMC		
Avalanche 1500 2WD	5.3L V-8	5,100 (b)
Avalanche 1500 2WD	5.3L V-8	5,600 (g)
Avalanche 1500 2WD	5.3L V-8	8,100 (g,p)
Avalanche 1500 2WD	6.2L V-8	8,100 (g)
Avalanche 1500 AWD	5.3L V-8	5,400 (g)
Avalanche 1500 AWD	5.3L V-8	7,800 (g,p)
Avalanche 1500 AWD	6.2L V-8	7,700 (g)
Traverse/Acadia FWD	3.6L V-6	2,000
Traverse/Acadia FWD	3.6L V-6	5,200 (t)
Traverse/Acadia AWD	3.6L V-6	2,000
Traverse/Acadia AWD	3.6L V-6	5,200 (t)
Colorado/Canyon Reg Cab 2WD	2.9L I-4	3,400 (a,i)
Colorado/Canyon Reg Cab 2WD	2.9L I-4	2,400 (m,i)
Colorado/Canyon Reg Cab 2WD	3.7L I-5	4,000 (a,i)
Colorado/Canyon Ext Cab 2WD	2.9L I-4	3,200 (a,i)
Colorado/Canyon Ext Cab 2WD	2.9L I-4	2,200 (m,i)
Colorado/Canyon Ext Cab 2WD	3.7L I-5	5,500 (a,i)
Colorado/Canyon Ext Cab 2WD	5.3L V-8	6,000 (a,g,l)
Colorado/Canyon Ext Cab 2WD	5.3L V-8	4,000 (a,g)*

*With sport suspension.

Colorado/Canyon CC 2WD	2.9L I-4	3,000 (a,i)
Colorado/Canyon CC 2WD	2.9L I-4	2,100 (m,i)
Colorado/Canyon CC 2WD	3.7L I-5	5,500 (a,g/i)
Colorado/Canyon CC 2WD	5.3L V-8	6,000 (a,g/i)
Colorado/Canyon Reg Cab 4WD	2.9L I-4	3,100 (a,i)
Colorado/Canyon Reg Cab 4WD	2.9L I-4	2,100 (m,i)
Colorado/Canyon Reg Cab 4WD	3.7L I-5	4,000 (a,i)
Colorado/Canyon Ext Cab 4WD	2.9L I-4	2,900 (a,i)
Colorado/Canyon Ext Cab 4WD	3.7L I-5	5,500 (a,i)
Colorado/Canyon Ext Cab 4WD	5.3L V-8	6,000 (a,g/i)
Colorado/Canyon CC 4WD	3.7L I-5	5,500 (a,i)
Colorado/Canyon CC 4WD	5.3L V-8	6,000 (a,g/k)
Equinox/Terrain	3.0 V-6	3,500
Express/Savana 1500 SWB CV 2WD	4.3L V-6	4,400
Express/Savana 1500 SWB CV 2WD	5.3L V-8	6,700 (g/i)
Express/Savana 1500 SWB CV AWD	5.3L V-8	6,500
Express/Savana 1500 SWB PV 2WD	5.3L V-8	6,200
Express/Savana 1500 SWB PV AWD	5.3L V-8	6,000
Express/Savana 2500 SWB CV 2WD	4.8L V-8	6,400 (i)
Express/Savana 2500 SWB CV 2WD	4.8L V-8	7,400 (k)
Express/Savana 2500 SWB CV 2WD	6.0L V-8	8,400 (i)
Express/Savana 2500 SWB CV 2WD	6.0L V-8	10,000 (k)
Express/Savana 2500 SWB PV 2WD	6.0L V-8	7,600 (i)
Express/Savana 2500 SWB PV 2WD	6.0L V-8	9,600 (k)
Express/Savana 2500 LWB CV 2WD	4.8L V-8	6,200 (i)
Express/Savana 2500 LWB CV 2WD	4.8L V-8	7,200 (k)
Express/Savana 2500 LWB CV 2WD	6.0L V-8	8,200 (i)
Express/Savana 2500 LWB CV 2WD	6.0L V-8	10,000 (k)
Express/Savana 3500 SWB CV 2WD	4.8L V-8	6,400 (i)
Express/Savana 3500 SWB CV 2WD	4.8L V-8	7,400 (k)
Express/Savana 3500 SWB CV 2WD	6.0L V-8	8,400 (i)
Express/Savana 3500 SWB CV 2WD	6.0L V-8	10,000 (k)
Express/Savana 3500 SWB PV 2WD	6.0L V-8	7,600 (i)
Express/Savana 3500 LWB CV 2WD	4.8L V-8	6,100 (i)
Express/Savana 3500 LWB CV 2WD	4.8L V-8	7,100 (k)
Express/Savana 3500 LWB CV 2WD	6.0L V-8	8,200 (i)
Express/Savana 3500 LWB CV 2WD	6.0L V-8	10,000 (k)
Express/Savana 3500 LWB PV 2WD	6.0L V-8	7,300 (i)

Silverado/Sierra 1500 Reg Cab, Std Bed

1500 Reg Cab Std Bed 2WD	4.3L V-6	4,800 (e)
1500 Reg Cab Std Bed 2WD	4.3L V-6	5,400 (i)
1500 Reg Cab Std Bed 2WD	4.8L V-8	4,700 (e)
1500 Reg Cab Std Bed 2WD	4.8L V-8	7,200 (i)
1500 Reg Cab Std Bed 2WD	5.3L V-8	6,600 (b)
1500 Reg Cab Std Bed 2WD	5.3L V-8	7,400 (b,p)
1500 Reg Cab Std Bed 2WD	5.3L V-8	9,100 (g,p)
1500 Reg Cab Std Bed 4WD	4.3L V-6	5,100 (i)
1500 Reg Cab Std Bed 4WD	4.8L V-8	6,000 (g)
1500 Reg Cab Std Bed 4WD	5.3L V-8	6,400 (b)
1500 Reg Cab Std Bed 4WD	5.3L V-8	7,100 (b,p)
1500 Reg Cab Std Bed 4WD	5.3L V-8	8,900 (g,p)

Silverado/Sierra 1500 Ext Cab, Std Bed

1500 Ext Cab Std Bed 2WD	4.3L V-6	4,400 (e)
1500 Ext Cab Std Bed 2WD	4.8L V-8	4,700 (e)

1500 Ext Cab Std Bed 2WD	4.8L V-8	6,700 (i)
1500 Ext Cab Std Bed 2WD	5.3L V-8	6,200 (b)
1500 Ext Cab Std Bed 2WD	5.3L V-8	6,900 (b,p)
1500 Ext Cab Std Bed 2WD	5.3L V-8	9,700 (g,p)
1500 Ext Cab Std Bed 2WD	6.2L V-8	6,700 (g)
1500 Ext Cab Std Bed 2WD	6.2L V-8	9,700 (g,p)
1500 Ext Cab Std Bed 2WD	6.2L V-8	10,700 (i,t)
1500 Ext Cab Std Bed 4WD	4.8L V-8	5,500 (g)
1500 Ext Cab Std Bed 4WD	5.3L V-8	6,100 (b)
1500 Ext Cab Std Bed 4WD	5.3L V-8	6,800 (b,p)
1500 Ext Cab Std Bed 4WD	5.3L V-8	9,600 (g)
1500 Ext Cab Std Bed 4WD	6.2L V-8	6,400 (g)
1500 Ext Cab Std Bed 4WD	6.2L V-8	9,400 (g,p)
1500 Ext Cab Std Bed 4WD	6.2L V-8	10,400 (i,t)

Silverado/Sierra 1500 CC, Shortbed

1500 CC Short Box 2WD	4.8L V-8	4,700 (e)
1500 CC Short Box 2WD	4.8L V-8	6,700 (i)
1500 CC Short Box 2WD	5.3L V-8	6,100 (b)
1500 CC Short Box 2WD	5.3L V-8	6,800 (b,p)
1500 CC Short Box 2WD (XFE)	5.3L V-8	7,000 (b)
1500 CC Short Box 2WD	5.3L V-8	9,600 (g,p)
1500 CC Short Box 2WD	6.2L V-8	6,600 (g)
1500 CC Short Box 2WD	6.2L V-8	9,600 (g,p)
1500 CC Short Box 2WD	6.2L V-8	10,600 (i,t)
1500 CC Short Box 4WD	4.8L V-8	5,500 (g)
1500 CC Short Box 4WD	5.3L V-8	6,000 (b)
1500 CC Short Box 4WD	5.3L V-8	6,700 (b,p)
1500 CC Short Box 4WD	5.3L V-8	9,500 (g)
1500 CC Short Box 4WD	6.2L V-8	6,400 (g)
1500 CC Short Box 4WD	6.2L V-8	9,400 (g,p)
1500 CC Short Box 4WD	6.2L V-8	10,400 (i,t)

Sierra Denali CC Shortbed, 1500 2WD and AWD

Sierra Denali CC Shortbed 2WD	6.2L V-8	6,600
Sierra Denali CC Shortbed 2WD	6.2L V-8	9,600 (p)
Sierra Denali CC Shortbed AWD	6.2L V-8	6,300
Sierra Denali CC Shortbed AWD	6.2L V-8	9,300 (p)

Silverado/Sierra 1500 Reg Cab LB

1500 Reg Cab LB 2WD	4.3L V-6	4,700 (e)
1500 Reg Cab LB 2WD	4.3L V-6	5,200 (i)
1500 Reg Cab LB 2WD	4.8L V-8	5,100 (e)
1500 Reg Cab LB 2WD	4.8L V-8	7,100 (i)
1500 Reg Cab LB 2WD	5.3L V-8	6,500 (b)
1500 Reg Cab LB 2WD	5.3L V-8	7,200 (b,p)
1500 Reg Cab LB 2WD	5.3L V-8	6,500 (a6,g)
1500 Reg Cab LB 2WD	5.3L V-8	10,000 (a6,g,p)
1500 Reg Cab LB 4WD	4.3L V-6	5,000 (i)
1500 Reg Cab LB 4WD	4.8L V-8	5,800 (g)
1500 Reg Cab LB 4WD	5.3L V-8	6,300 (b)
1500 Reg Cab LB 4WD	5.3L V-8	7,000 (b,p)
1500 Reg Cab LB 4WD	5.3L V-8	9,800 (g,p)

Silverado/Sierra 1500 Ext Cab LB

1500 Ext Cab LB 2WD	5.3L V-8	6,000 (b)
---------------------	----------	-----------

1500 Ext Cab LB 2WD	5.3L V-8	6,700 (b,p)
1500 Ext Cab LB 2WD	5.3L V-8	9,500 (g,p)

Silverado/Sierra Two-Mode Hybrid

Two-mode hybrid 2WD	6.0L V-8	6,100
Two-mode hybrid 4WD	6.0L V-8	5,900

Travel-trailer ratings are shown on standard and long-box models; fifth-wheel ratings may be considerably lower. Shortbed models are neither designed, nor intended, to tow a fifth-wheel trailer.

Silverado/Sierra 2500 Ext Cab Std Bed

2500 Ext Cab Std Bed 2WD	6.0L V-8	10,200 (i)
2500 Ext Cab Std Bed 2WD	6.0L V-8	12,700 (k)
2500 Ext Cab Std Bed 2WD	6.6L V-8 TD	15,500 (i)
2500 Ext Cab Std Bed 4WD	6.0L V-8	9,900 (j)
2500 Ext Cab Std Bed 4WD	6.0L V-8	12,400 (k)
2500 Ext Cab Std Bed 4WD	6.6L V-8 TD	14,500 (i)

Silverado/Sierra 2500 CC Std Bed

2500 CC Std Bed 2WD	6.0L V-8	10,000 (i)
2500 CC Std Bed 2WD	6.0L V-8	12,500 (k)
2500 CC Std Bed 2WD	6.6L V-8 TD	15,300 (i)
2500 CC Std Bed 4WD	6.0L V-8	9,800 (j)
2500 CC Std Bed 4WD	6.0L V-8	12,300 (k)
2500 CC Std Bed 4WD	6.6L V-8 TD	13,900 (i)

Silverado/Sierra 2500 Reg Cab LB

2500 Reg Cab LB 2WD	6.0L V-8	10,500 (i)
2500 Reg Cab LB 2WD	6.0L V-8	13,000 (k)
2500 Reg Cab LB 2WD	6.6L V-8 TD	15,800 (i)
2500 Reg Cab LB 4WD	6.0L V-8	10,200 (j)
2500 Reg Cab LB 4WD	6.0L V-8	12,700 (k)
2500 Reg Cab LB 4WD	6.6L V-8 TD	15,500 (i)

Silverado/Sierra 2500 Ext Cab LB

2500 Ext Cab LB 2WD	6.0L V-8	10,000 (i)
2500 Ext Cab LB 2WD	6.0L V-8	12,500 (k)
2500 Ext Cab LB 2WD	6.6L V-8 TD	15,300 (i)
2500 Ext Cab LB 4WD	6.0L V-8	9,800 (j)
2500 Ext Cab LB 4WD	6.0L V-8	12,300 (k)
2500 Ext Cab LB 4WD	6.6L V-8 TD	13,800 (i)

Silverado/Sierra 2500 CC LB

2500 CC LB 2WD	6.0L V-8	9,900 (i)
2500 CC LB 2WD	6.0L V-8	12,400 (k)
2500 CC LB 2WD	6.6L V-8 TD	14,500 (i)
2500 CC LB 4WD	6.0L V-8	9,600 (j)
2500 CC LB 4WD	6.0L V-8	12,100 (k)
2500 CC LB 4WD	6.6L V-8 TD	13,000 (i)

Silverado/Sierra 3500 Reg Cab

3500 Reg Cab SRW 4WD	6.0L V-8	10,000 (i)
3500 Reg Cab SRW 4WD	6.0L V-8	12,500 (k)
3500 Reg Cab SRW 4WD	6.6L V-8 TD	15,400 (i)
3500 Reg Cab DRW 4WD	6.0L V-8	9,700 (j)
3500 Reg Cab DRW 4WD	6.0L V-8	12,200 (k)

3500 Reg Cab DRW 4WD	6.6L V-8 TD	16,500 (i)
----------------------	-------------	------------

Silverado/Sierra 3500 Ext Cab

3500 Ext Cab SRW 2WD	6.0L V-8	9,900 (i)
3500 Ext Cab SRW 2WD	6.0L V-8	12,400 (k)
3500 Ext Cab SRW 2WD	6.6L V-8 TD	15,400 (i)
3500 Ext Cab DRW 2WD	6.0L V-8	9,500 (j)
3500 Ext Cab DRW 2WD	6.0L V-8	12,000 (k)
3500 Ext Cab DRW 2WD	6.6L V-8 TD	16,300 (i)
3500 Ext Cab SRW 4WD	6.0L V-8	9,600 (j)
3500 Ext Cab SRW 4WD	6.0L V-8	12,100 (k)
3500 Ext Cab SRW 4WD	6.6L V-8 TD	14,900 (i)
3500 Ext Cab DRW 4WD	6.0L V-8	9,200 (j)
3500 Ext Cab DRW 4WD	6.0L V-8	11,700 (k)
3500 Ext Cab DRW 4WD	6.6L V-8 TD	16,100 (i)

Silverado/Sierra 3500 CC

3500 CC SRW 2WD	6.0L V-8	9,700 (j)
3500 CC SRW 2WD	6.0L V-8	12,200 (k)
3500 CC SRW 2WD	6.6L V-8 TD	15,100 (i)
3500 CC DRW 2WD	6.0L V-8	9,300 (k)
3500 CC DRW 2WD	6.0L V-8	11,800 (k)
3500 CC DRW 2WD	6.6L V-8 TD	16,200 (i)
3500 CC SRW 4WD	6.0L V-8	9,400 (j)
3500 CC SRW 4WD	6.0L V-8	11,900 (k)
3500 CC SRW 4WD	6.6L V-8 TD	14,800 (i)
3500 CC DRW 4WD	6.0L V-8	9,100 (j)
3500 CC DRW 4WD	6.0L V-8	11,600 (k)
3500 CC DRW 4WD	6.6L V-8 TD	15,900 (i)

Chevy Tahoe and Suburban, GMC Yukon, Yukon XL, Yukon and Yukon XL Denali 1500 Series

Tahoe/Yukon 2WD	5.3L V-8	5,400 (b)
Tahoe/Yukon 2WD	5.3L V-8	5,900 (g)
Tahoe/Yukon 2WD	5.3L V-8	8,400 (g,p)
Tahoe/Yukon Two-Mode Hybrid, 2WD	6.0L V-8	6,200
Tahoe/Yukon 4WD	5.3L V-8	5,200 (b)
Tahoe/Yukon 4WD	5.3L V-8	5,700 (g)
Tahoe/Yukon 4WD	5.3L V-8	8,200 (g,p)
Tahoe/Yukon Two-Mode Hybrid, 4WD	6.0L V-8	6,000
Suburban/Yukon XL 2WD	5.3L V-8	5,100 (b)
Suburban/Yukon XL 2WD	5.3L V-8	5,600 (g)
Suburban/Yukon XL 2WD	5.3L V-8	8,100 (g,p)
Suburban/Yukon XL 2WD	6.2L V-8	8,100 (g)
Suburban/Yukon XL 4WD	5.3L V-8	5,400 (g)
Suburban/Yukon XL 4WD	5.3L V-8	7,900 (g,p)
Suburban/Yukon XL 4WD	6.2L V-8	7,900
Yukon Denali 2WD	6.2L V-8	8,300
Yukon Denali Two-Mode Hybrid, 2WD	6.0L V-8	6,000
Yukon Denali AWD	6.2L V-8	8,100
Yukon Denali Two-Mode Hybrid, AWD	6.0L V-8	5,700
Yukon XL Denali 2WD	6.2L V-8	7,600
Yukon XL Denali AWD	6.2L V-8	7,900

Chevy Suburban, GMC Yukon XL 2500

2500 Long Wheelbase 2WD	6.0L V-8	9,600
-------------------------	----------	-------

2500 Long Wheelbase 4WD	6.0L V-8	9,300
-------------------------	----------	-------

CHRYSLER/DODGE

Chrysler 300	3.5L V-6	2,000
Chrysler 300	5.7L V-8	2,000
Caliber	2.4L I-4	2,000 (t)
Charger	3.5L V-6	2,000
Charger	5.7L V-8	2,000
Grand Caravan	3.8L V-6	3,800 (t)
Grand Caravan	4.0L V-6	3,800 (t)
Journey	3.5L V-6	3,500 (t)
Town and Country	3.8L V-6	3,800 (t)
Town and Country	4.0L V-6	3,800 (t)

Dodge Dakota Shortbed

Dakota Ext Cab SB 2WD	3.7L V-6	4,650 (a4,h)
Dakota Ext Cab SB 2WD	3.7L V-6	4,950 (a4,j)
Dakota Ext Cab SB 2WD	4.7L V-8	6,050 (a5,h)
Dakota Ext Cab SB 2WD	4.7L V-8	7,250 (a5,j)
Dakota Ext Cab SB 4WD	3.7L V-6	4,750 (a4,j)
Dakota Ext Cab SB 4WD	4.7L V-8	5,850 (a5,h)
Dakota Ext Cab SB 4WD	4.7L V-8	7,050 (a5,j)
Dakota CC SB 2WD	3.7L V-6	4,500 (a4,h)
Dakota CC SB 2WD	3.7L V-6	4,800 (a4,j)
Dakota CC SB 2WD	4.7L V-8	5,850 (a5,h)
Dakota CC SB 2WD	4.7L V-8	7,050 (a5,j)
Dakota CC SB 4WD	3.7L V-8	4,650 (a4,j)
Dakota CC SB 4WD	4.7L V-8	5,700 (a5,h)
Dakota CC SB 4WD	4.7L V-8	6,900 (a5,j)

Ratings shown are for the ST trim level. Ratings may be reduced slightly in SXT, TRX and Laramie, depending on model (regular, extended or crew cab).

Ram 1500 Regular Cab Shortbed

1500 Reg Cab SB 2WD	3.7L V-6	3,800 (a4,h/j)
1500 Reg Cab SB 2WD	4.7L V-8	6,650 (a5,r)
1500 Reg Cab SB 2WD	4.7L V-8	7,650 (a5,j)
1500 Reg Cab SB 2WD	5.7L V-8	6,100 (a5,d)
1500 Reg Cab SB 2WD	5.7L V-8	8,100 (a5,h)
1500 Reg Cab SB 2WD	5.7L V-8	9,100 (a5,j)
1500 Reg Cab SB 4WD	4.7L V-8	6,500 (a5,h*)
1500 Reg Cab SB 4WD	4.7L V-8	7,450 (a5,j*)
1500 Reg Cab SB 4WD	5.7L V-8	7,900 (a5,h*)
1500 Reg Cab SB 4WD	5.7L V-8	8,850 (a5,j)

Ram 1500 Regular Cab Longbed

1500 Reg Cab LB 2WD	3.7L V-6	3,650 (a4,j)
1500 Reg Cab LB 2WD	4.7L V-8	6,500 (a5,h)
1500 Reg Cab LB 2WD	4.7L V-8	7,500 (a5,j)
1500 Reg Cab LB 2WD	5.7L V-8	5,950 (a5,d)
1500 Reg Cab LB 2WD	5.7L V-8	7,950 (a5,h)
1500 Reg Cab LB 2WD	5.7L V-8	10,450 (a5,j)
1500 Reg Cab LB 4WD	4.7L V-8	6,300 (a5,h*)
1500 Reg Cab LB 4WD	4.7L V-8	7,300 (a5,j*)
1500 Reg Cab LB 4WD	5.7L V-8	7,750 (a5,h*)
1500 Reg Cab LB 4WD	5.7L V-8	10,250 (a5,j*)

*Ratings for LT265 tires. LT275 tires rated 50-100 pounds less, depending on model.

Ram 1500 Quad Cab

Ram 1500 Quad Cab 2WD	3.7L V-6	3,400 (a4,j)
Ram 1500 Quad Cab 2WD	4.7L V-8	6,250 (a5,h)
Ram 1500 Quad Cab 2WD	4.7L V-8	7,250 (a5,j)
Ram 1500 Quad Cab 2WD	5.7L V-8	5,800 (a5,d)
Ram 1500 Quad Cab 2WD	5.7L V-8	7,700 (a5,h)
Ram 1500 Quad Cab 2WD	5.7L V-8	10,200 (a5,j)
Ram 1500 Quad Cab 4WD	4.7L V-8	6,050 (a5,h)
Ram 1500 Quad Cab 4WD	4.7L V-8	7,050 (a5,j)
Ram 1500 Quad Cab 4WD	5.7L V-8	7,500 (a5,h)
Ram 1500 Quad Cab 4WD	5.7L V-8	10,000 (a5,j)

Ram 1500 Crew Cab

Ram 1500 CC 2WD	4.7L V-8	6,200 (a5,h)
Ram 1500 CC 2WD	4.7L V-8	7,200 (a5,j)
Ram 1500 CC 2WD	5.7L V-8	5,700 (a5,d)
Ram 1500 CC 2WD	5.7L V-8	7,700 (a5,h)
Ram 1500 CC 2WD	5.7L V-8	10,200 (a5,j)
Ram 1500 CC 4WD	4.7L V-8	6,000 (a5,h)
Ram 1500 CC 4WD	4.7L V-8	7,000 (a5,j)
Ram 1500 CC 4WD	5.7L V-8	7,450 (a5,h)
Ram 1500 CC 4WD	5.7L V-8	9,950 (a5,j)

Ratings shown are for models with 17-inch wheels. Models with 20-inch wheels have slightly lower ratings, depending on model and equipment. See dealer for details.

Ram 2500 Regular Cab Longbed

Ram 2500 LB 2WD	5.7L V-8	9,350 (a5,i)
Ram 2500 LB 2WD	5.7L V-8	11,350 (a5,k)
Ram 2500 LB 2WD	6.7L I-6 TD	12,350 (m6,g)
Ram 2500 LB 2WD	6.7L I-6 TD	13,350 (m6,i)
Ram 2500 LB 2WD	6.7L I-6 TD	10,450 (a6,g)
Ram 2500 LB 2WD	6.7L I-6 TD	13,450 (a6,i/k)
Ram 2500 LB 4WD	5.7L V-8	8,950 (a5,i)
Ram 2500 LB 4WD	5.7L V-8	10,950 (a5,k)
Ram 2500 LB 4WD	6.7L I-6 TD	12,000 (m6,g)
Ram 2500 LB 4WD	6.7L I-6 TD	13,000 (m6,i)
Ram 2500 LB 4WD	6.7L I-6 TD	10,100 (a6,g)
Ram 2500 LB 4WD	6.7L I-6 TD	13,100 (a6,i/k)

Ram 2500 Crew Cab Shortbed

Ram 2500 CC SB 2WD	5.7L V-8	9,100 (a5,i)
Ram 2500 CC SB 2WD	5.7L V-8	11,100 (a5,k)
Ram 2500 CC SB 2WD	6.7L I-6 TD	12,100 (m6,g)
Ram 2500 CC SB 2WD	6.7L I-6 TD	13,100 (m6,i)
Ram 2500 CC SB 2WD	6.7L I-6 TD	10,250 (a6,g)
Ram 2500 CC SB 2WD	6.7L I-6 TD	13,250 (a6,i)
Ram 2500 CC SB 4WD	5.7L V-8	8,600 (a5,i)
Ram 2500 CC SB 4WD	5.7L V-8	10,600 (a5,k)
Ram 2500 Power Wagon 4WD	5.7L V-8	10,250 (a5,o)
Ram 2500 CC SB 4WD	6.7L I-6 TD	11,700 (m6,g)
Ram 2500 CC SB 4WD	6.7L I-6 TD	12,700 (m6,i)
Ram 2500 CC SB 4WD	6.7L I-6 TD	9,750 (a6,g)
Ram 2500 CC SB 4WD	6.7L I-6 TD	12,750 (a6,i/k)

Ram 2500 Crew Cab Longbed

Ram 2500 CC LB 2WD	5.7L V-8	8,900 (a5,i)
Ram 2500 CC LB 2WD	5.7L V-8	10,900 (a5,k)
Ram 2500 CC LB 2WD	6.7L I-6 TD	12,000 (m6,g)
Ram 2500 CC LB 2WD	6.7L I-6 TD	13,000 (m6,i)
Ram 2500 CC LB 2WD	6.7L I-6 TD	10,050 (a6,g)
Ram 2500 CC LB 2WD	6.7L I-6 TD	13,050 (a6,i/k)
Ram 2500 CC LB 4WD	5.7L V-8	8,500 (a5,i)
Ram 2500 CC LB 4WD	5.7L V-8	10,500 (a5,k)
Ram 2500 CC LB 4WD	6.7L I-6 TD	11,600 (m6,g)
Ram 2500 CC LB 4WD	6.7L I-6 TD	12,600 (m6,i)
Ram 2500 CC LB 4WD	6.7L I-6 TD	9,650 (a6,g)
Ram 2500 CC LB 4WD	6.7L I-6 TD	12,650 (a6,i/k)

Ram 2500 Mega Cab

Ram 2500 Mega Cab 2WD	5.7L V-8	8,600 (a5,i)
Ram 2500 Mega Cab 2WD	5.7L V-8	10,600 (a5,k)
Ram 2500 Mega Cab 2WD	6.7L I-6 TD	11,750 (m6,g)
Ram 2500 Mega Cab 2WD	6.7L I-6 TD	12,750 (m6,i)
Ram 2500 Mega Cab 2WD	6.7L I-6 TD	9,850 (a6,g)
Ram 2500 Mega Cab 2WD	6.7L I-6 TD	12,850 (a6,i/k)
Ram 2500 Mega Cab 4WD	5.7L V-8	8,150 (a5,i)
Ram 2500 Mega Cab 4WD	5.7L V-8	10,150 (a5,k)
Ram 2500 Mega Cab 4WD	6.7L I-6 TD	11,300 (m6,g)
Ram 2500 Mega Cab 4WD	6.7L I-6 TD	12,300 (m6,i)
Ram 2500 Mega Cab 4WD	6.7L I-6 TD	9,400 (a6,g)
Ram 2500 Mega Cab 4WD	6.7L I-6 TD	12,400 (a6,i/k)

Ram 3500 Regular Cab Longbed

Ram 3500 Regular Cab LB DRW 2WD	6.7L I-6 TD	12,000 (m6,g)
Ram 3500 Regular Cab LB DRW 2WD	6.7L I-6 TD	14,000 (m6,i)
Ram 3500 Regular Cab LB DRW 2WD	6.7L I-6 TD	10,100 (a6,g)
Ram 3500 Regular Cab LB DRW 2WD	6.7L I-6 TD	14,100 (a6,i)
Ram 3500 Regular Cab LB DRW 2WD	6.7L I-6 TD	18,500 (a6,k)
Ram 3500 Regular Cab LB DRW 4WD	6.7L I-6 TD	11,700 (m6,g)
Ram 3500 Regular Cab LB DRW 4WD	6.7L I-6 TD	13,700 (m6,i)
Ram 3500 Regular Cab LB DRW 4WD	6.7L I-6 TD	9,800 (a6,g)
Ram 3500 Regular Cab LB DRW 4WD	6.7L I-6 TD	13,800 (a6,i)
Ram 3500 Regular Cab LB DRW 4WD	6.7L I-6 TD	18,200 (a6,k)

Ram 3500 Crew Cab Shortbed

Ram 3500 CC SB SRW 2WD	6.7L I-6 TD	12,150 (m6,g)
Ram 3500 CC SB SRW 2WD	6.7L I-6 TD	14,150 (m6,i)
Ram 3500 CC SB SRW 2WD	6.7L I-6 TD	10,250 (a6,g)
Ram 3500 CC SB SRW 2WD	6.7L I-6 TD	14,250 (a6,i)
Ram 3500 CC SB SRW 2WD	6.7L I-6 TD	17,250 (a6,k)
Ram 3500 CC SB SRW 4WD	6.7L I-6 TD	11,800 (m6,g)
Ram 3500 CC SB SRW 4WD	6.7L I-6 TD	13,800 (m6,i)
Ram 3500 CC SB SRW 4WD	6.7L I-6 TD	9,900 (a6,g)
Ram 3500 CC SB SRW 4WD	6.7L I-6 TD	13,900 (a6,i)
Ram 3500 CC SB SRW 4WD	6.7L I-6 TD	16,900 (a6,k)

Ram 3500 Crew Cab Longbed

Ram 3500 CC LB SRW 2WD	6.7L I-6 TD	11,850 (m6,g)
Ram 3500 CC LB SRW 2WD	6.7L I-6 TD	13,850 (m6,i)
Ram 3500 CC LB SRW 2WD	6.7L I-6 TD	9,900 (a6,g)

Ram 3500 CC LB SRW 2WD	6.7L I-6 TD	13,900 (a6,i)
Ram 3500 CC LB SRW 2WD	6.7L I-6 TD	16,900 (a6,k)
Ram 3500 CC LB DRW 2WD	6.7L I-6 TD	11,550 (m6,g)
Ram 3500 CC LB DRW 2WD	6.7L I-6 TD	13,550 (m6,i)
Ram 3500 CC LB DRW 2WD	6.7L I-6 TD	9,650 (a6,g)
Ram 3500 CC LB DRW 2WD	6.7L I-6 TD	13,650 (a6,i)
Ram 3500 CC LB DRW 2WD	6.7L I-6 TD	18,050 (a6,k)
Ram 3500 CC LB SRW 4WD	6.7L I-6 TD	11,700 (m6,g)
Ram 3500 CC LB SRW 4WD	6.7L I-6 TD	13,700 (m6,i)
Ram 3500 CC LB SRW 4WD	6.7L I-6 TD	9,800 (a6,g)
Ram 3500 CC LB SRW 4WD	6.7L I-6 TD	13,800 (a6,i)
Ram 3500 CC LB SRW 4WD	6.7L I-6 TD	16,800 (a6,k)
Ram 3500 CC LB DRW 4WD	6.7L I-6 TD	11,350 (m6,g)
Ram 3500 CC LB DRW 4WD	6.7L I-6 TD	13,350 (m6,i)
Ram 3500 CC LB DRW 4WD	6.7L I-6 TD	9,450 (a6,g)
Ram 3500 CC LB DRW 4WD	6.7L I-6 TD	13,450 (a6,i)
Ram 3500 CC LB DRW 4WD	6.7L I-6 TD	17,850 (a6,k)

Ram 3500 Mega Cab

Ram 3500 Mega Cab SRW 2WD	6.7L I-6 TD	11,750 (m6,g)
Ram 3500 Mega Cab SRW 2WD	6.7L I-6 TD	13,750 (m6,i)
Ram 3500 Mega Cab SRW 2WD	6.7L I-6 TD	9,800 (a6,g)
Ram 3500 Mega Cab SRW 2WD	6.7L I-6 TD	13,800 (a6,i)
Ram 3500 Mega Cab SRW 2WD	6.7L I-6 TD	16,800 (a6,k)
Ram 3500 Mega Cab DRW 2WD	6.7L I-6 TD	11,400 (m6,g)
Ram 3500 Mega Cab DRW 2WD	6.7L I-6 TD	13,400 (m6,i)
Ram 3500 Mega Cab DRW 2WD	6.7L I-6 TD	9,500 (a6,g)
Ram 3500 Mega Cab DRW 2WD	6.7L I-6 TD	13,500 (a6,i)
Ram 3500 Mega Cab DRW 2WD	6.7L I-6 TD	17,900 (a6,k)
Ram 3500 Mega Cab SRW 4WD	6.7L I-6 TD	11,350 (m6,g)
Ram 3500 Mega Cab SRW 4WD	6.7L I-6 TD	13,350 (m6,i)
Ram 3500 Mega Cab SRW 4WD	6.7L I-6 TD	9,450 (a6,g)
Ram 3500 Mega Cab SRW 4WD	6.7L I-6 TD	13,450 (a6,i)
Ram 3500 Mega Cab SRW 4WD	6.7L I-6 TD	16,450 (a6,k)
Ram 3500 Mega Cab DRW 4WD	6.7L I-6 TD	11,000 (m6,g)
Ram 3500 Mega Cab DRW 4WD	6.7L I-6 TD	13,000 (m6,i)
Ram 3500 Mega Cab DRW 4WD	6.7L I-6 TD	9,050 (a6,g)
Ram 3500 Mega Cab DRW 4WD	6.7L I-6 TD	13,050 (a6,i)
Ram 3500 Mega Cab DRW 4WD	6.7L I-6 TD	17,450 (a6,k)

2011 Ram 3500/4500/5500 Chassis Cab

3500 Regular Chassis Cab SRW 2WD	6.7L I-6 TD	12,443 (m,g)
3500 Regular Chassis Cab SRW 2WD	6.7L I-6 TD	17,443 (m,i/k)
3500 Regular Chassis Cab SRW 2WD	6.7L I-6 TD	17,379 (a,k)
3500 Regular Chassis Cab SRW 4WD	6.7L I-6 TD	12,216 (m,g)
3500 Regular Chassis Cab SRW 4WD	6.7L I-6 TD	17,216 (m,i/k)
3500 Regular Chassis Cab SRW 4WD	6.7L I-6 TD	17,152 (a,k)
3500 Regular Chassis Cab DRW 2WD	5.7L V-8	10,937 (a,k)
3500 Regular Chassis Cab DRW 2WD	6.7L I-6 TD	12,170 (m,g)
3500 Regular Chassis Cab DRW 2WD	6.7L I-6 TD	17,170 (m,i)
3500 Regular Chassis Cab DRW 2WD	6.7L I-6 TD	19,170 (m,k)
3500 Regular Chassis Cab DRW 2WD	6.7L I-6 TD	17,106 (a,k)
3500 Regular Chassis Cab DRW 4WD	5.7L V-8	10,679 (a5,k)
3500 Regular Chassis Cab DRW 4WD	6.7L I-6 TD	11,910 (m,g)
3500 Regular Chassis Cab DRW 4WD	6.7L I-6 TD	16,910 (m,i)
3500 Regular Chassis Cab DRW 4WD	6.7L I-6 TD	18,910 (m,k)

3500 Regular Chassis Cab DRW 4WD	6.7L I-6 TD	16,846 (a6,k)
----------------------------------	-------------	---------------

Note: Weights shown are for 3500 Regular Chassis Cab models with a 143.5-inch wheelbase. Weights for longer-wheelbase models are somewhat less.

3500 Crew Chassis Cab SRW 2WD	6.7L I-6 TD	11,939 (m,g)
3500 Crew Chassis Cab SRW 2WD	6.7L I-6 TD	16,939 (m,i/k)
3500 Crew Chassis Cab SRW 2WD	6.7L I-6 TD	16,875 (a,k)
3500 Crew Chassis Cab SRW 4WD	6.7L I-6 TD	11,676 (m,g)
3500 Crew Chassis Cab SRW 4WD	6.7L I-6 TD	16,676 (m,i/k)
3500 Crew Chassis Cab SRW 4WD	6.7L I-6 TD	16,612 (a,k)
3500 Crew Chassis Cab DRW 2WD	5.7L V-8	10,593 (a5,k)
3500 Crew Chassis Cab DRW 2WD	6.7L I-6 TD	11,635 (m,g)
3500 Crew Chassis Cab DRW 2WD	6.7L I-6 TD	16,635 (m,i)
3500 Crew Chassis Cab DRW 2WD	6.7L I-6 TD	18,635 (m,k)
3500 Crew Chassis Cab DRW 2WD	6.7L I-6 TD	16,571 (a6,k)
3500 Crew Chassis Cab DRW 4WD	5.7L V-8	10,135 (a5,k)
3500 Crew Chassis Cab DRW 4WD	6.7L I-6 TD	11,375 (m,g)
3500 Crew Chassis Cab DRW 4WD	6.7L I-6 TD	16,375 (m,i)
3500 Crew Chassis Cab DRW 4WD	6.7L I-6 TD	18,375 (m,k)
3500 Crew Chassis Cab DRW 4WD	6.7L I-6 TD	16,311 (a6,k)

Note: Weights shown are for 3500 Crew Chassis Cab models with a 173.5-inch wheelbase. Weights for 197.5-inch wheelbase models are somewhat less.

4500 Regular Cab DRW 2WD	6.7L I-6 TD	18,300 (m,k/n)
4500 Regular Cab DRW 2WD	6.7L I-6 TD	18,250 (a,n/q)
4500 Regular Cab DRW 4WD	6.7L I-6 TD	17,950 (m,k/n)
4500 Regular Cab DRW 4WD	6.7L I-6 TD	17,900 (a,n/q)

Note: Weights shown are for 4500 Regular Chassis Cab models with a 144.5-inch wheelbase. Weights for longer-wheelbase models are somewhat less.

4500 Crew Chassis Cab DRW 2WD	6.7L I-6 TD	17,600 (m,k/n)
4500 Crew Chassis Cab DRW 2WD	6.7L I-6 TD	17,550 (a,n/q)
4500 Crew Chassis Cab DRW 4WD	6.7L I-6 TD	17,300 (m,k/n)
4500 Crew Chassis Cab DRW 4WD	6.7L I-6 TD	17,250 (a,n/q)

Weights shown are for 4500 Crew Chassis Cab models with a 173.5-inch wheelbase. Weights for 197.5-inch models are somewhat less.

5500 Regular Chassis Cab DRW 2WD	6.7L I-6 TD	18,250 (m,n)
5500 Regular Chassis Cab DRW 2WD	6.7L I-6 TD	18,200 (a,q)
5500 Regular Chassis Cab DRW 4WD	6.7L I-6 TD	17,950 (m,n)
5500 Regular Chassis Cab DRW 4WD	6.7L I-6 TD	17,850 (a,q)

Note: Weights shown are for 5500 Regular Chassis Cab models with a 144.5-inch wheelbase. Weights for longer-wheelbase models are somewhat less.

5500 Crew Chassis Cab DRW 2WD	6.7L I-6 TD	17,550 (m,n)
5500 Crew Chassis Cab DRW 2WD	6.7L I-6 TD	17,500 (a,q)
5500 Crew Chassis Cab DRW 4WD	6.7L I-6 TD	17,250 (m,n)
5500 Crew Chassis Cab DRW 4WD	6.7L I-6 TD	17,200 (a,q)

Note: Weights shown are for 5500 Crew Chassis Cab models with a 173.5-inch wheelbase. Weights for 197.5-inch models are somewhat less.

FORD

E-Series Van/Wagon

E-150 Van	4.6L V-8	6,000 (i)
E-150 Van	4.6L V-8	6,500 (k)

E-150 Van	5.4L V-8	7,400 (i/k)
E-150 Extended Van	4.6L V-8	5,900 (j)
E-150 Extended Van	4.6L V-8	6,400 (k)
E-150 Extended Van	5.4L V-8	7,300 (i/k)
E-250 Van	4.6L V-8	6,000 (j)
E-250 Van	4.6L V-8	6,500 (k)
E-250 Van	5.4L V-8	7,400 (i/k)
E-250 Extended Van	4.6L V-8	5,900 (j)
E-250 Extended Van	4.6L V-8	6,400 (k)
E-250 Extended Van	5.4L V-8	7,300 (i/k)
E-350 Super Duty Van	5.4L V-8	7,300 (i/k)
E-350 Super Duty Van	6.8L V-10	9,100 (j)
E-350 Super Duty Van	6.8L V-10	10,000 (k)
E-350 Super Duty Van	6.0L V-8 TD	9,600 (h)
E-350 Super Duty Van	6.0L V-8 TD	10,000 (k)
E-350 Super Duty Extended Van	5.4L V-8	7,200 (i/k)
E-350 Super Duty Extended Van	6.8L V-10	9,000 (j)
E-350 Super Duty Extended Van	6.8L V-10	10,000 (k)
E-350 Super Duty Extended Van	6.0L V-8 TD	9,500 (h)
E-350 Super Duty Extended Van	6.0L V-8 TD	10,000 (k)
E-150 Wagon	4.6L V-8	5,600 (j)
E-150 Wagon	4.6L V-8	6,100 (k)
E-150 Wagon	5.4L V-8	7,000 (i/k)
E-350 Super Duty Wagon	5.4L V-8	6,700 (i/k)
E-350 Super Duty Wagon	6.8L V-10	8,500 (j)
E-350 Super Duty Wagon	6.8L V-10	10,000 (k)
E-350 Super Duty Ext. Wagon	5.4L V-8	6,500 (i/k)*
E-350 Super Duty Ext. Wagon	6.8L V-10	8,300 (j)*
E-350 Super Duty Ext. Wagon	6.8L V-10	10,000 (k)*

**Ratings for 11-passenger van. Ratings for 14-15 passenger van up to 200 pounds less.*

Edge, Escape, Explorer, Expedition, Flex

Edge	3.5L V-6	2,000
Edge	3.5L V-6	3,500 (t)
Escape 2WD/4WD	3.0L V-6	3,500 (t)
Escape 2WD/4WD Hybrid	3.0L V-6	3,500 (t)
Explorer 2WD	4.0L V-6	3,500 (h/i)
Explorer 2WD	4.0L V-6	5,375 (t)
Explorer 4WD	4.0L V-6	3,500 (h)
Explorer 4WD	4.0L V-6	5,205 (t)
Explorer 4WD	4.6L V-8	3,500 (h)
Explorer 4WD	4.6L V-8	7,115 (h,t)
Explorer AWD	4.0L V-6	3,500 (h)
Explorer AWD	4.0L V-6	5,000 (t)
Explorer AWD	4.6L V-8	7,115 (h)
Sport Trac 2WD	4.0L V-6	5,250 (j)
Sport Trac 2WD	4.6L V-8	7,160 (h)
Sport Trac 2WD/AWD	4.0L V-6	5,080 (j)
Sport Trac 2WD/AWD	4.6L V-8	6,990 (h)
Expedition 2WD/4WD	5.4L V-8	6,000 (all)
Expedition 2WD	5.4L V-8	9,200 (t)
Expedition 4WD	5.4L V-8	8,900 (t)
Expedition EL 2WD	5.4L V-8	6,000
Expedition EL 2WD	5.4L V-8	8,900 (t)
Expedition EL 4WD	5.4L V-8	6,000

Expedition EL 4WD	5.4L V-8	8,700 (t)
Flex	3.5L V-6	2,000
Flex	3.5L V-6	4,500 (t)

Ranger

Ranger Regular Cab SB 2WD	2.3L I-4	2,200
Ranger Regular Cab LB 2WD	2.3L I-4	2,160
Ranger Regular Cab LB 2WD	4.0L V-6	5,940
Ranger SuperCab 2WD	4.0L V-6	3,300 (m)
Ranger SuperCab 2WD	4.0L V-6	3,220 (m*)
Ranger SuperCab 2WD	4.0L V-6	5,760
Ranger SuperCab 2WD	4.0L V-6	5,660
Ranger SuperCab 4WD	4.0L V-6	3,080 (m)
Ranger SuperCab 4WD	4.0L V-6	5,540

*Ranger Sport.

F-150

F-150 Reg. Cab SB 2WD	4.6L V-8 2V	5,400 (a4,h)
F-150 Reg. Cab SB 2WD	4.6L V-8 2V	5,900 (a4,i)
F-150 Reg. Cab LB 2WD	4.6L V-8 2V	5,500 (a4,h)
F-150 Reg. Cab LB 2WD	4.6L V-8 2V	6,000 (a4,i)
F-150 Reg. Cab LB 2WD	4.6L V-8 3V	8,000 (a6,f)
F-150 Reg. Cab LB 2WD	4.6L V-8 3V	8,400 (a6,h)
F-150 Reg. Cab LB 2WD	5.4L V-8	8,000 (a6,c)
F-150 Reg. Cab LB 2WD	5.4L V-8	9,800 (a6,h)
F-150 Reg. Cab LB 2WD	5.4L V-8	11,300 (a6,i)
F-150 Reg. Cab SB 4WD	4.6L V-8 2V	5,700 (a4,i)
F-150 Reg. Cab SB 4WD	4.6L V-8 3V	7,700 (a6,h)
F-150 Reg. Cab SB 4WD	4.6L V-8 3V	8,000 (a6,i)
F-150 Reg. Cab SB 4WD	5.4L V-8	7,700 (a6,f)
F-150 Reg. Cab SB 4WD	5.4L V-8	8,600 (a6,h/i)
F-150 Reg. Cab LB 4WD	4.6L V-8 2V	5,800 (a4,i)
F-150 Reg. Cab LB 4WD	4.6L V-8 3V	7,700 (a6,h)
F-150 Reg. Cab LB 4WD	4.6L V-8 3V	8,200 (a6,i)
F-150 Reg. Cab LB 4WD	5.4L V-8	7,700 (a6,f)
F-150 Reg. Cab LB 4WD	5.4L V-8	9,500 (a6,h)
F-150 Reg. Cab LB 4WD	5.4L V-8	11,300 (a6,i,t)
F-150 SuperCab Std. Bed 2WD	4.6L V-8 2V	5,300 (a4,h)
F-150 SuperCab Std. Bed 2WD	4.6L V-8 2V	5,800 (a4,i)
F-150 SuperCab Std. Bed 2WD	4.6L V-8 3V	8,100 (a6,f)
F-150 SuperCab Std. Bed 2WD	4.6L V-8 3V	9,500 (a6,h)
F-150 SuperCab Std. Bed 2WD	5.4L V-8	8,600 (a6,c)
F-150 SuperCab Std. Bed 2WD	5.4L V-8	9,800 (a6,h)
F-150 SuperCab Std. Bed 2WD	5.4L V-8	11,300 (a6,i,t)
F-150 SuperCab LB 2WD	5.4L V-8	11,300 (a6,i,t)
F-150 SuperCab Short Bed 4WD	5.4L V-8	6,000 (a6,k)
F-150 SuperCab Std. Bed 4WD	4.6L V-8 2V	5,500 (a4,i)
F-150 SuperCab Std. Bed 4WD	4.6L V-8 3V	7,900 (a6,h)
F-150 SuperCab Std. Bed 4WD	4.6L V-8 3V	9,400 (a6,i)
F-150 SuperCab Std. Bed 4WD	5.4L V-8	8,300 (a6,f)
F-150 SuperCab Std. Bed 4WD	5.4L V-8	9,700 (a6,h)
F-150 SuperCab Std. Bed 4WD	5.4L V-8	11,200 (a6,i,t)
F-150 SuperCab LB 4WD	5.4L V-8	11,100 (a6,s,z)
F-150 SuperCrew Cab Short Bed 2WD	4.6L V-8 2V	5,200 (a4,h)
F-150 SuperCrew Cab Short Bed 2WD	4.6L V-8 2V	5,700 (a4,i)
F-150 SuperCrew Cab Short Bed 2WD	4.6L V-8 3V	8,100 (a6,f)

F-150 SuperCrew Cab Short Bed 2WD	4.6L V-8 3V	9,400 (a6,h)
F-150 SuperCrew Cab Short Bed 2WD	5.4L V-8	8,500 (a6,c)
F-150 SuperCrew Cab Short Bed 2WD	5.4L V-8	9,800 (a6,h)
F-150 SuperCrew Cab H-D Edition 2WD	5.4L V-8	5,300 (a6,i)
F-150 SuperCrew Cab Short Bed 2WD	5.4L V-8	11,300 (a6,i)
F-150 SuperCrew Cab Std. Bed 2WD	4.6L V-8 2V	5,100 (a4,h)
F-150 SuperCrew Cab Std. Bed 2WD	4.6L V-8 2V	5,600 (a4,i)
F-150 SuperCrew Cab Std. Bed 2WD	4.6L V-8 3V	8,000 (a6,f)
F-150 SuperCrew Cab Std. Bed 2WD	4.6L V-8 3V	9,300 (a6,h)
F-150 SuperCrew Cab Std. Bed 2WD	5.4L V-8	8,400 (a6,c)
F-150 SuperCrew Cab Std. Bed 2WD	5.4L V-8	9,700 (a6,h)
F-150 SuperCrew Cab Std. Bed 2WD	5.4L V-8	11,300 (a6,i,t)
F-150 SuperCrew Cab Short Bed 4WD	4.6L V-8 3V	7,700 (a6,h)
F-150 SuperCrew Cab Short Bed 4WD	4.6L V-8 3V	9,300 (a6,i)
F-150 SuperCrew Cab Short Bed 4WD	5.4L V-8	8,100 (a6,f)
F-150 SuperCrew Cab Short Bed 4WD	5.4L V-8	9,600 (a6,h)
F-150 SuperCrew H-D Edition 4WD	5.4L V-8	5,100 (a6,i)
F-150 SuperCrew Cab Short Bed 4WD	5.4L V-8	11,200 (a6,i,t)
F-150 SuperCrew Cab Std. Bed 4WD	4.6L V-8 3V	7,600 (a6,h)
F-150 SuperCrew Cab Std. Bed 4WD	4.6L V-8 3V	9,200 (a6,i)
F-150 SuperCrew Cab Std. Bed 4WD	5.4L V-8	8,000 (a6,f)
F-150 SuperCrew Cab Std. Bed 4WD	5.4L V-8	9,500 (a6,h)
F-150 SuperCrew Cab Std. Bed 4WD	5.4L V-8	11,100 (a6,i,t)

F-250/F-350/F-450 Super Duty, Conventional Towing, Automatic Transmission*

*Models with 5.4-liter V-8 and manual transmission tow 1,000 pounds less.

F-250/350 Reg. Cab SRW 2WD	5.4L V-8	10,200 (i)
F-250/350 Reg. Cab SRW 2WD	5.4L V-8	12,200 (k)
F-250/350 Reg. Cab SRW 2WD	6.8L V-10	12,500 (k,l)
F-250/350 Reg. Cab SRW 2WD	6.4L V-8 TD	12,500 (all)
F-250/350 Reg. Cab SRW 4WD	5.4L V-8	9,800 (i)
F-250/350 Reg. Cab SRW 4WD	5.4L V-8	11,800 (k)
F-250/350 Reg. Cab SRW 4WD	6.8L V-10	12,500 (k/l)
F-250/350 Reg. Cab SRW 4WD	6.4L V-8 TD	12,500 (all)
F-350 Reg. Cab DRW 2WD	5.4L V-8	12,200 (k)
F-350 Reg. Cab DRW 2WD	6.8L V-10	15,000 (all)
F-350 Reg. Cab DRW 2WD	6.4L V-8 TD	15,000 (all)
F-350 Reg. Cab DRW 4WD	5.4L V-8	11,800 (k)
F-350 Reg. Cab DRW 4WD	6.8L V-10	15,000 (all)
F-350 Reg. Cab DRW 4WD	6.4L V-8 TD	15,000 (all)
F-250/F350 SuperCab SRW 2WD	5.4L V-8	10,000 (i)
F-250/F350 SuperCab SRW 2WD	5.4L V-8	12,000 (k)
F-250/F350 SuperCab SRW 2WD	6.8L V-10	12,500 (all)
F-250/F350 SuperCab SRW 2WD	6.4L V-8 TD	12,500 (all)
F-250/F350 SuperCab SRW 4WD	5.4L V-8	9,500 (i)
F-250/F350 SuperCab SRW 4WD	5.4L V-8	11,500 (k)
F-250/F350 SuperCab SRW 4WD	6.8L V-10	12,500 (all)
F-250/F350 SuperCab SRW 4WD	6.4L V-8 TD	12,500 (all)
F-350 SuperCab DRW 2WD	5.4L V-8	11,800 (k)
F-350 SuperCab DRW 2WD	6.8 V-10	15,000 (all)
F-350 SuperCab DRW 2WD	6.4L V-8 TD	15,000 (all)
F-350 SuperCab DRW 4WD	5.4L V-8	11,400 (k)
F-350 SuperCab DRW 4WD	6.8 V-10	15,000 (all)
F-350 SuperCab DRW 4WD	6.4L V-8 TD	15,000 (all)
F-250/350 CC SRW 2WD	5.4L V-8	9,700 (i)

F-250/350 CC SRW 2WD	5.4L V-8	11,700 (k)
F-250/350 CC SRW 2WD	6.8L V-10	12,500 (all)
F-250/350 CC SRW 2WD	6.4L V-8 TD	12,500 (all)
F-250/350 CC SRW 4WD	5.4L V-8	9,300 (i)
F-250/350 CC SRW 4WD	5.4L V-8	11,300 (k)
F-250/350 CC SRW 4WD	6.8L V-10	12,500 (all)
F-250/350 CC SRW 4WD	6.4L V-8 TD	12,500 (all)
F-350 CC DRW 2WD	5.4L V-8	11,600 (k)
F-350 CC DRW 2WD	6.8L V-10	15,000 (all)
F-350 CC DRW 2WD	6.4L V-8 TD	15,000 (all)
F-350 CC DRW 4WD	5.4L V-8	11,200 (k)
F-350 CC DRW 4WD	6.8L V-10	15,000 (all)
F-350 CC DRW 4WD	6.4L V-8 TD	15,000 (all)
F-450 DRW 2WD	6.4L V-8 TD	16,000 (all)
F-450 DRW 4WD	6.4L V-8 TD	16,000 (all)

F-250/F-350/F-450 Super Duty, Fifth-Wheel Towing, Automatic Transmission

F-250/F-350 Regular Cab SRW 2WD	5.4L V-8	10,200 (i)
F-250/F-350 Regular Cab SRW 2WD	5.4L V-8	12,200 (k)
F-250/F-350 Regular Cab SRW 2WD	6.8L V-10	15,000 (k)
F-250/F-350 Regular Cab SRW 2WD	6.8L V-10	16,500/16,900 (l)
F-250/F-350 Regular Cab SRW 2WD	6.4L V-8 TD	16,300 (f/h)
F-250/F-350 Regular Cab SRW 4WD	5.4L V-8	9,800 (i)
F-250/F-350 Regular Cab SRW 4WD	5.4L V-8	11,800 (k)
F-250/F-350 Regular Cab SRW 4WD	6.8L V-10	14,600 (k)
F-250/F-350 Regular Cab SRW 4WD	6.8L V-10	16,100/16,500 (l)
F-250/F-350 Regular Cab SRW 4WD	6.4L V-8 TD	15,800 (f/h)
F-350 Regular Cab DRW 2WD	5.4L V-8	12,200 (k)
F-350 Regular Cab DRW 2WD	6.8L V-10	16,600 (k)
F-350 Regular Cab DRW 2WD	6.4 V-8 TD	16,300 (i)
F-350 Regular Cab DRW 2WD	6.4 V-8 TD	18,800 (k,p)
F-350 Regular Cab DRW 4WD	5.4L V-8	11,800 (k)
F-350 Regular Cab DRW 4WD	6.8L V-10	16,100 (k)
F-350 Regular Cab DRW 4WD	6.4 V-8 TD	15,800 (i)
F-350 Regular Cab DRW 4WD	6.4 V-8 TD	18,300 (k,p)
F-250/F350 SuperCab SRW 2WD	5.4L V-8	10,000 (i)
F-250/F350 SuperCab SRW 2WD	5.4L V-8	12,000 (k)
F-250/F350 SuperCab SRW 2WD	6.8L V-10	14,800 (k)
F-250/F350 SuperCab SRW 2WD	6.8L V-10	16,300/16,700 (l)
F-250/F350 SuperCab SRW 2WD	6.4L V-8 TD	16,000 (f/h)
F-250/F350 SuperCab SRW 4WD	5.4L V-8	9,500 (i)
F-250/F350 SuperCab SRW 4WD	5.4L V-8	11,500 (k)
F-250/F350 SuperCab SRW 4WD	6.8L V-10	14,400 (k)
F-250/F350 SuperCab SRW 4WD	6.8L V-10	15,900/16,200 (l)
F-250/F350 SuperCab SRW 4WD	6.8L V-10	15,500 (f/h)
F-350 SuperCab DRW 2WD	5.4L V-8	11,800 (k)
F-350 SuperCab DRW 2WD	6.8L V-10	16,200 (k)
F-350 SuperCab DRW 2WD	6.4L V-8 TD	15,900 (i)
F-350 SuperCab DRW 2WD	6.4L V-8 TD	18,400 (k,p)
F-350 SuperCab DRW 4WD	5.4L V-8	11,400 (k)
F-350 SuperCab DRW 4WD	6.8L V-10	15,800 (k)
F-350 SuperCab DRW 4WD	6.4L V-8 TD	15,500 (i)
F-350 SuperCab DRW 4WD	6.4L V-8 TD	18,000 (k,p)
F-250/F-350 CC SRW 2WD	5.4L V-8	9,700 (i)
F-250/F-350 CC SRW 2WD	5.4L V-8	11,700 (k)

F-250/F-350 CC SRW 2WD	6.8L V-10	14,600 (k)
F-250/F-350 CC SRW 2WD	6.8L V-10	16,100/16,400 (l)
F-250/F-350 CC SRW 2WD	6.4L V-8 TD	15,800 (f/h)
F-250/F-350 CC SRW 4WD	5.4L V-8	9,300 (i)
F-250/F-350 CC SRW 4WD	5.4L V-8	11,300 (k)
F-250/F-350 CC SRW 4WD	6.8L V-10	14,100 (k)
F-250/F-350 CC SRW 4WD	6.8L V-10	15,600/16,000 (l)
F-250/F-350 CC SRW 4WD	6.4L V-8 TD	15,300 (f/h)
F-350 CC DRW 2WD	5.4L V-8	11,600 (k)
F-350 CC DRW 2WD	6.8L V-10	16,000 (k)
F-350 CC DRW 2WD	6.4L V-8 TD	15,700 (i)
F-350 CC DRW 2WD	6.4L V-8 TD	18,200 (k,p)
F-350 CC DRW 4WD	5.4L V-8	11,200 (k)
F-350 CC DRW 4WD	6.8L V-10	15,500 (k)
F-350 CC DRW 4WD	6.4L V-8 TD	15,200 (i)
F-350 CC DRW 4WD	6.4L V-8 TD	17,700 (k,p)
F-450 CC DRW 2WD	6.4L V-8 TD	24,600 (l,t)
F-450 CC DRW 4WD	6.4L V-8 TD	24,200 (l,t)

F-250/F-350/F-450 Super Duty, Fifth-Wheel Towing, Manual Transmission

F-250/F-350 Reg. Cab SRW 2WD	5.4L V-8	9,200 (i)
F-250/F-350 Reg. Cab SRW 2WD	5.4L V-8	11,200 (k)
F-250/F-350 Reg. Cab SRW 2WD	6.8L V-10	14,000 (k)
F-250/F-350 Reg. Cab SRW 2WD	6.8L V-10	16,000 (l)
F-250/F-350 Reg. Cab SRW 4WD	5.4L V-8	8,800 (i)
F-250/F-350 Reg. Cab SRW 4WD	5.4L V-8	10,800 (k)
F-250/F-350 Reg. Cab SRW 4WD	6.8L V-10	13,600 (k)
F-250/F-350 Reg. Cab SRW 4WD	6.8L V-10	15,600 (l)
F-250/F-350 Reg. Cab SRW 4WD	6.4L V-8 TD	15,800 (h)
F-350 Reg. Cab DRW 4WD	6.4L V-8 TD	15,800 (i/k)
F-250/F-350 SuperCab SRW 4WD	5.4L V-8	8,500 (i)
F-250/F-350 SuperCab SRW 4WD	5.4L V-8	10,500 (k)
F-250/F-350 SuperCab SRW 4WD	6.8L V-10	13,400 (k)
F-250/F-350 SuperCab SRW 4WD	6.8L V-10	15,400 (l)
F-250/F-350 SuperCab SRW 4WD	6.4L V-8 TD	15,500 (h)
F-350 SuperCab DRW 4WD	6.4L V-8 TD	15,500 (i/k)
F-250/F-350 CC SRW 4WD	5.4L V-8	8,300 (i)
F-250/F-350 CC SRW 4WD	5.4L V-8	10,300 (k)
F-250/F-350 CC SRW 4WD	6.8L V-10	13,100 (k)
F-250/F-350 CC SRW 4WD	6.8L V-10	15,100 (l)
F-250/F-350 CC SRW 4WD	6.4L V-8 TD	15,300 (h)
F-350 CC DRW 4WD	6.4L V-8 TD	15,200 (i/k)
F-450 CC DRW 4WD	6.4L V-8 TD	18,200 (l)

F-350/F-450/F-550 Super Duty Chassis Cab, Conventional Towing, Automatic Transmission

F-350 Reg. Chassis Cab SRW 2WD	5.4L V-8	9,500 (i)
F-350 Reg. Chassis Cab SRW 2WD	5.4L V-8	11,500 (k)
F-350 Reg. Chassis Cab SRW 2WD	6.8 V-10	12,500 (all)
F-350 Reg. Chassis Cab SRW 2WD	6.4L V-8 TD	12,500 (all)
F-350 Reg. Chassis Cab SRW 4WD	5.4L V-8	9,100 (i)
F-350 Reg. Chassis Cab SRW 4WD	5.4L V-8	11,100 (k)
F-350 Reg. Chassis Cab SRW 4WD	6.8 V-10	12,500 (all)
F-350 Reg. Chassis Cab SRW 4WD	6.4L V-8 TD	12,500 (all)
F-350 Reg. Chassis Cab DRW 2WD	5.4L V-8	9,600 (i)

F-350 Reg. Chassis Cab DRW 2WD	5.4L V-8	11,600 (k)
F-350 Reg. Chassis Cab DRW 2WD	6.8L V-10	14,500 (k)
F-350 Reg. Chassis Cab DRW 2WD	6.8L V-10	15,000 (l)
F-350 Reg. Chassis Cab DRW 2WD	6.4L V-8 TD	15,000 (i/k)
F-350 Reg. Chassis Cab DRW 4WD	5.4L V-8	9,200 (j)
F-350 Reg. Chassis Cab DRW 4WD	5.4L V-8	11,200 (k)
F-350 Reg. Chassis Cab DRW 4WD	6.8L V-10	14,100 (k)
F-350 Reg. Chassis Cab DRW 4WD	6.8L V-10	15,000 (l)
F-350 Reg. Chassis Cab DRW 4WD	6.4L V-8 TD	15,000 (i/k)
F-450 Reg. Chassis Cab DRW 2WD	6.8L V-10	16,000 (all)
F-450 Reg. Chassis Cab DRW 2WD	6.4L V-8 TD	16,000 (all)
F-450 Reg. Chassis Cab DRW 4WD	6.8L V-10	16,000 (all)
F-450 Reg. Chassis Cab DRW 4WD	6.4L V-8 TD	16,000 (all)
F-550 Reg. Chassis Cab DRW 2WD	6.8L V-10	16,000 (all)
F-550 Reg. Chassis Cab DRW 2WD	6.4L V-8 TD	16,000 (all)
F-550 Reg. Chassis Cab DRW 4WD	6.8L V-10	16,000 (all)
F-550 Reg. Chassis Cab DRW 4WD	6.4L V-8 TD	16,000 (all)
F-350 Super Chassis Cab SRW 2WD	5.4L V-8	9,200 (j)
F-350 Super Chassis Cab SRW 2WD	5.4L V-8	11,200 (k)
F-350 Super Chassis Cab SRW 2WD	6.8L V-10	12,500 (all)
F-350 Super Chassis Cab SRW 2WD	6.4L V-8 TD	12,500 (all)
F-350 Super Chassis Cab SRW 4WD	5.4L V-8	8,700 (j)
F-350 Super Chassis Cab SRW 4WD	5.4L V-8	10,700 (k)
F-350 Super Chassis Cab SRW 4WD	6.8L V-10	12,500 (all)
F-350 Super Chassis Cab SRW 4WD	5.4L V-8	12,500 (all)
F-350 Super Chassis Cab DRW 2WD	5.4L V-8	9,300 (j)
F-350 Super Chassis Cab DRW 2WD	5.4L V-8	11,300 (k)
F-350 Super Chassis Cab DRW 2WD	6.8L V-10	14,100 (k)
F-350 Super Chassis Cab DRW 2WD	6.8L V-10	15,000 (l)
F-350 Super Chassis Cab DRW 2WD	6.4L V-8 TD	15,000 (i/k)
F-350 Super Chassis Cab DRW 4WD	5.4L V-8	8,800 (j)
F-350 Super Chassis Cab DRW 4WD	5.4L V-8	10,800 (k)
F-350 Super Chassis Cab DRW 4WD	6.8L V-10	13,700 (k)
F-350 Super Chassis Cab DRW 4WD	6.8L V-10	15,000 (l)
F-350 Super Chassis Cab DRW 4WD	6.4L V-8 TD	14,900
F-450 Super Chassis Cab DRW 2WD	6.8L V-10	16,000 (all)
F-450 Super Chassis Cab DRW 2WD	6.4L V-8 TD	16,000 (all)
F-450 Super Chassis Cab DRW 4WD	6.8L V-10	16,000 (all)
F-450 Super Chassis Cab DRW 4WD	6.4L V-8 TD	16,000 (all)
F-550 Super Chassis Cab DRW 2WD	6.8L V-10	16,000 (all)
F-550 Super Chassis Cab DRW 2WD	6.4L V-8 TD	16,000 (all)
F-550 Super Chassis Cab DRW 4WD	6.8L V-10	16,000 (all)
F-550 Super Chassis Cab DRW 4WD	6.4L V-8 TD	16,000 (all)
F-350 Crew Chassis Cab SRW 2WD	5.4L V-8	9,000 (j)
F-350 Crew Chassis Cab SRW 2WD	5.4L V-8	11,000 (k)
F-350 Crew Chassis Cab SRW 2WD	6.8L V-10	12,500 (k)
F-350 Crew Chassis Cab SRW 2WD	6.4L V-8 TD	12,500 (j)
F-350 Crew Chassis Cab SRW 4WD	5.4L V-8	8,500 (j)
F-350 Crew Chassis Cab SRW 4WD	5.4L V-8	10,500 (k)
F-350 Crew Chassis Cab SRW 4WD	6.8L V-10	12,500 (k)
F-350 Crew Chassis Cab SRW 4WD	6.4L V-8 TD	12,500 (j)
F-350 Crew Chassis Cab DRW 2WD	5.4L V-8	9,100 (j)
F-350 Crew Chassis Cab DRW 2WD	5.4L V-8	11,100 (k)
F-350 Crew Chassis Cab DRW 2WD	6.8L V-10	14,000 (k)
F-350 Crew Chassis Cab DRW 2WD	6.8L V-10	15,000 (l)
F-350 Crew Chassis Cab DRW 2WD	6.4L V-8 TD	15,000 (i/k)

F-350 Crew Chassis Cab DRW 4WD	5.4L V-8	8,600 (j)
F-350 Crew Chassis Cab DRW 4WD	5.4L V-8	10,600 (k)
F-350 Crew Chassis Cab DRW 4WD	6.8L V-10	13,500 (k)
F-350 Crew Chassis Cab DRW 4WD	6.8L V-10	15,000 (l)
F-350 Crew Chassis Cab DRW 4WD	6.4L V-8 TD	14,700 (i/k)
F-450 Crew Chassis Cab DRW 2WD	6.8L V-10	16,000 (all)
F-450 Crew Chassis Cab DRW 2WD	6.4L V-8 TD	16,000 (all)
F-450 Crew Chassis Cab DRW 4WD	6.8L V-10	16,000 (all)
F-450 Crew Chassis Cab DRW 4WD	6.4L V-8 TD	16,000 (all)
F-550 Crew Chassis Cab DRW 2WD	6.8L V-10	16,000 (all)
F-550 Crew Chassis Cab DRW 2WD	6.4L V-8 TD	16,000 (all)
F-550 Crew Chassis Cab DRW 4WD	6.8L V-10	16,000 (all)
F-550 Crew Chassis Cab DRW 4WD	6.4L V-8 TD	16,000 (all)

F-350/F-450/F-550 Super Duty Chassis Cab, Conventional Towing, Manual Transmission

F-350 Reg. Chassis Cab DRW 2WD	5.4L V-8	8,100 (j)
F-350 Reg. Chassis Cab DRW 2WD	5.4L V-8	10,600 (k)
F-350 Reg. Chassis Cab DRW 2WD	6.8L V-10	13,500 (k)
F-350 Reg. Chassis Cab DRW 2WD	6.8L V-10	15,000 (l)
F-350 Reg. Chassis Cab DRW 2WD	6.4L V-8 TD	15,000 (i/k)
F-350 Reg. Chassis Cab DRW 4WD	5.4L V-8	7,700 (j)
F-350 Reg. Chassis Cab DRW 4WD	5.4L V-8	10,200 (k)
F-350 Reg. Chassis Cab DRW 4WD	6.8L V-10	13,100 (k)
F-350 Reg. Chassis Cab DRW 4WD	6.8L V-10	15,000 (l)
F-350 Reg. Chassis Cab DRW 4WD	6.4L V-8 TD	15,000 (k)
F-450 Reg. Chassis Cab DRW 2WD	6.8L V-10	16,000 (all)
F-450 Reg. Chassis Cab DRW 2WD	6.4L V-8 TD	16,000 (all)
F-450 Reg. Chassis Cab DRW 4WD	6.8L V-10	16,000 (all)
F-450 Reg. Chassis Cab DRW 4WD	6.4L V-8 TD	16,000 (all)
F-550 Reg. Chassis Cab DRW 2WD	6.8L V-10	16,000 (all)
F-550 Reg. Chassis Cab DRW 2WD	6.4L V-8 TD	16,000 (all)
F-550 Reg. Chassis Cab DRW 4WD	6.8L V-10	16,000 (all)
F-550 Reg. Chassis Cab DRW 4WD	6.4L V-8 TD	16,000 (all)
F-350 Super Chassis Cab DRW 4WD	5.4L V-8	7,300 (j)
F-350 Super Chassis Cab DRW 4WD	5.4L V-8	9,800 (k)
F-350 Super Chassis Cab DRW 4WD	6.8L V-10	12,700 (k)
F-350 Super Chassis Cab DRW 4WD	6.8L V-10	14,700 (l)
F-350 Super Chassis Cab DRW 4WD	6.4L V-8 TD	14,900 (i/k)
F-450 Super Chassis Cab DRW 4WD	6.8L V-10	16,000 (all)
F-450 Super Chassis Cab DRW 4WD	6.4L V-8 TD	16,000 (all)
F-550 Super Chassis Cab DRW 4WD	6.8L V-10	16,000 (all)
F-550 Super Chassis Cab DRW 4WD	6.4L V-8 TD	16,000 (all)
F-350 Crew Chassis Cab DRW 4WD	5.4L V-8	7,100 (j)
F-350 Crew Chassis Cab DRW 4WD	5.4L V-8	9,600 (k)
F-350 Crew Chassis Cab DRW 4WD	6.8L V-10	12,500 (k)
F-350 Crew Chassis Cab DRW 4WD	6.8L V-10	14,500 (l)
F-350 Crew Chassis Cab DRW 4WD	6.4L V-8 TD	14,700 (i/k)
F-450 Crew Chassis Cab DRW 4WD	6.8L V-10	16,000 (all)
F-450 Crew Chassis Cab DRW 4WD	6.4L V-8 TD	16,000 (all)
F-550 Crew Chassis Cab DRW 4WD	6.8L V-10	16,000 (all)
F-550 Crew Chassis Cab DRW 4WD	6.4L V-8 TD	16,000 (all)

F-350/F-450/F-550 Super Duty Chassis Cab, Fifth-Wheel Towing, Automatic Transmission

F-350 Reg. Chassis Cab, SRW 2WD	5.4L V-8	9,500 (j)
---------------------------------	----------	-----------

F-350 Reg. Chassis Cab, SRW 2WD	5.4L V-8	11,500 (k)
F-350 Reg. Chassis Cab, SRW 2WD	6.8L V-10	14,400 (k)
F-350 Reg. Chassis Cab, SRW 2WD	6.4L V-8 TD	15,600 (i)
F-350 Reg. Chassis Cab, SRW 4WD	5.4L V-8	9,100 (i)
F-350 Reg. Chassis Cab, SRW 4WD	5.4L V-8	11,100 (k)
F-350 Reg. Chassis Cab, SRW 4WD	6.8L V-10	14,000 (k)
F-350 Reg. Chassis Cab, SRW 4WD	6.4L V-8 TD	15,100 (j)
F-350 Reg. Chassis Cab, DRW 2WD	5.4L V-8	9,600 (i)
F-350 Reg. Chassis Cab, DRW 2WD	5.4L V-8	11,600 (k)
F-350 Reg. Chassis Cab, DRW 2WD	6.8L V-10	14,500 (k)
F-350 Reg. Chassis Cab, DRW 2WD	6.4L V-8 TD	15,700 (i/k)
F-350 Reg. Chassis Cab DRW 4WD	5.4L V-8	9,200 (i)
F-350 Reg. Chassis Cab DRW 4WD	5.4L V-8	11,200 (k)
F-350 Reg. Chassis Cab DRW 4WD	6.8L V-10	14,100 (k)
F-350 Reg. Chassis Cab DRW 4WD	6.8L V-10	15,600 (l)
F-350 Reg. Chassis Cab DRW 4WD	6.4L V-8 TD	15,300 (i/k)
F-450 Reg. Chassis Cab DRW 2WD	6.8L V-10	18,400 (q/r)
F-450 Reg. Chassis Cab DRW 2WD	6.4L V-8 TD	17,600 (l)
F-450 Reg. Chassis Cab DRW 2WD	6.4L V-8 TD	21,600 (l,t)
F-450 Reg. Chassis Cab DRW 4WD	6.8L V-10	18,100 (q/r)
F-450 Reg. Chassis Cab DRW 4WD	6.4L V-8 TD	17,200 (l)
F-450 Reg. Chassis Cab DRW 4WD	6.4L V-8 TD	21,200 (l,t)
F-550 Reg. Chassis Cab DRW 2WD	6.8L V-10	18,400 (q/r)
F-550 Reg. Chassis Cab DRW 2WD	6.4L V-8 TD	17,600 (l)
F-550 Reg. Chassis Cab DRW 2WD	6.4L V-8 TD	24,600 (q,t)
F-550 Reg. Chassis Cab DRW 4WD	6.8L V-10	18,100 (q/r)
F-550 Reg. Chassis Cab DRW 4WD	6.4L V-8 TD	17,200 (l)
F-550 Reg. Chassis Cab DRW 4WD	6.4L V-8 TD	24,200 (q,t)

Manufacturer's note: Weights shown are for 141-inch wheelbase DRW models. For 165, 189 and 201-inch wheelbase models, weights may be somewhat less (200-400 pounds, depending on model).

F-350 Super Chassis Cab SRW 2WD	5.4L V-8	9,200 (i)
F-350 Super Chassis Cab SRW 2WD	5.4L V-8	11,200 (k)
F-350 Super Chassis Cab SRW 2WD	6.8L V-10	14,000 (k)
F-350 Super Chassis Cab SRW 2WD	6.4L V-8 TD	15,100 (j)
F-350 Super Chassis Cab SRW 4WD	5.4L V-8	8,700 (i)
F-350 Super Chassis Cab SRW 4WD	5.4L V-8	10,700 (k)
F-350 Super Chassis Cab SRW 4WD	6.8L V-10	13,600 (k)
F-350 Super Chassis Cab SRW 4WD	6.4L V-8 TD	14,700 (i)
F-350 Super Chassis Cab DRW 2WD	5.4L V-8	9,300 (i)
F-350 Super Chassis Cab DRW 2WD	5.4L V-8	11,300 (k)
F-350 Super Chassis Cab DRW 2WD	6.8L V-10	14,100 (k)
F-350 Super Chassis Cab DRW 2WD	6.8L V-10	15,600 (l)
F-350 Super Chassis Cab DRW 2WD	6.4L V-8 TD	15,300 (i/k)
F-350 Super Chassis Cab DRW 4WD	5.4L V-8	8,800 (i)
F-350 Super Chassis Cab DRW 4WD	5.4L V-8	10,800 (k)
F-350 Super Chassis Cab DRW 4WD	6.8L V-10	13,700 (k)
F-350 Super Chassis Cab DRW 4WD	6.8L V-10	15,200 (l)
F-350 Super Chassis Cab DRW 4WD	6.4L V-8 TD	14,900 (i/k)
F-450 Super Chassis Cab DRW 2WD	6.8L V-10	18,000 (q/r)
F-450 Super Chassis Cab DRW 2WD	6.4L V-8 TD	17,200 (l)
F-450 Super Chassis Cab DRW 2WD	6.4L V-8 TD	21,200 (l,t)
F-450 Super Chassis Cab DRW 4WD	6.8L V-10	17,700 (q/r)
F-450 Super Chassis Cab DRW 4WD	6.4L V-8 TD	16,800 (l)
F-450 Super Chassis Cab DRW 4WD	6.4L V-8 TD	20,800 (l,t)

F-550 Super Chassis Cab DRW 2WD	6.8L V-10	18,000 (q/r)
F-550 Super Chassis Cab DRW 2WD	6.4L V-8 TD	17,200 (l)
F-550 Super Chassis Cab DRW 2WD	6.4L V-8 TD	17,100 (q)
F-550 Super Chassis Cab DRW 2WD	6.4L V-8 TD	24,100 (q,t)
F-550 Super Chassis Cab DRW 4WD	6.8L V-10	17,700 (q/r)
F-550 Super Chassis Cab DRW 4WD	6.4L V-8 TD	16,800 (l)
F-550 Super Chassis Cab DRW 4WD	6.4L V-8 TD	16,700 (q)
F-550 Super Chassis Cab DRW 4WD	6.4L V-8 TD	23,800 (q,t)
F-350 Crew Chassis Cab SRW 2WD	5.4L V-8	9,000 (i)
F-350 Crew Chassis Cab SRW 2WD	5.4L V-8	11,000 (k)
F-350 Crew Chassis Cab SRW 2WD	6.8L V-10	13,900 (k)
F-350 Crew Chassis Cab SRW 2WD	6.4L V-8 TD	15,000 (i)
F-350 Crew Chassis Cab SRW 4WD	5.4L V-8	8,500 (i)
F-350 Crew Chassis Cab SRW 4WD	5.4L V-8	10,500 (k)
F-350 Crew Chassis Cab SRW 4WD	6.8L V-10	13,400 (k)
F-350 Crew Chassis Cab SRW 4WD	6.4L V-8 TD	14,500 (i)
F-350 Crew Chassis Cab DRW 2WD	5.4L V-8	9,100 (i)
F-350 Crew Chassis Cab DRW 2WD	5.4L V-8	11,100 (k)
F-350 Crew Chassis Cab DRW 2WD	6.8L V-10	14,000 (k)
F-350 Crew Chassis Cab DRW 2WD	6.8L V-10	15,500 (l)
F-350 Crew Chassis Cab DRW 2WD	6.4L V-8 TD	15,200 (i/k)
F-350 Crew Chassis Cab DRW 4WD	5.4L V-8	8,600 (i)
F-350 Crew Chassis Cab DRW 4WD	5.4L V-8	10,600 (k)
F-350 Crew Chassis Cab DRW 4WD	6.8L V-10	13,500 (k)
F-350 Crew Chassis Cab DRW 4WD	6.8L V-10	15,000 (l)
F-350 Crew Chassis Cab DRW 4WD	6.4L V-8 TD	14,700 (i/k)
F-450 Crew Chassis Cab DRW 2WD	6.8L V-10	17,800 (q/r)
F-450 Crew Chassis Cab DRW 2WD	6.4L V-8 TD	17,000 (l)
F-450 Crew Chassis Cab DRW 2WD	6.4L V-8 TD	21,000 (l,t)
F-450 Crew Chassis Cab DRW 4WD	6.8L V-10	17,500 (q/r)
F-450 Crew Chassis Cab DRW 4WD	6.4L V-8 TD	16,700 (l)
F-450 Crew Chassis Cab DRW 4WD	6.4L V-8 TD	20,700 (l,t)
F-550 Crew Chassis Cab DRW 2WD	6.8L V-10	17,900 (q/r)
F-550 Crew Chassis Cab DRW 2WD	6.4L V-8 TD	17,000 (l)
F-550 Crew Chassis Cab DRW 2WD	6.4L V-8 TD	16,900 (q)
F-550 Crew Chassis Cab DRW 2WD	6.4L V-8 TD	23,900 (q,t)
F-550 Crew Chassis Cab DRW 4WD	6.8L V-10	17,500 (q/r)
F-550 Crew Chassis Cab DRW 4WD	6.4L V-8 TD	16,700 (l)
F-550 Crew Chassis Cab DRW 4WD	6.4L V-8 TD	16,500 (q)
F-550 Crew Chassis Cab DRW 4WD	6.4L V-8 TD	23,700 (q,t)

Manufacturer's note: Weights shown are for 176-inch wheelbase DRW models. For 200 inch wheelbase models, weight may be somewhat less (100-200 pounds, depending on model).

F-350/F-450/F-550 Super Duty Chassis Cab, Fifth-Wheel Towing, Manual Transmission

F-350 Reg. Chassis Cab SRW 2WD	5.4L V-8	8,100 (i)
F-350 Reg. Chassis Cab SRW 2WD	5.4L V-8	10,600 (k)
F-350 Reg. Chassis Cab SRW 2WD	6.8L V-10	13,500 (k)
F-350 Reg. Chassis Cab SRW 2WD	6.8L V-10	15,500 (l)
F-350 Reg. Chassis Cab SRW 2WD	6.4L V-8 TD	15,700 (i/k)
F-350 Reg. Chassis Cab SRW 4WD	5.4L V-8	7,700 (i)
F-350 Reg. Chassis Cab SRW 4WD	5.4L V-8	10,200 (k)
F-350 Reg. Chassis Cab SRW 4WD	6.8L V-10	13,100 (k/l)
F-350 Reg. Chassis Cab SRW 4WD	6.8L V-10	15,100 (l)
F-350 Reg. Chassis Cab SRW 4WD	6.4L V-8 TD	15,300 (i/k)

F-450 Reg. Chassis Cab DRW 2WD	6.8L V-10	18,400 (q/r)
F-450 Reg. Chassis Cab DRW 2WD	6.8L V-10	17,600 (l)
F-450 Reg. Chassis Cab DRW 2WD	6.4L V-8 TD	19,600 (q,t)
F-450 Reg. Chassis Cab DRW 4WD	6.8L V-10	18,100 (q/r)
F-450 Reg. Chassis Cab DRW 4WD	6.8L V-10	17,200 (l)
F-450 Reg. Chassis Cab DRW 4WD	6.4L V-8 TD	19,200 (q,t)
F-550 Reg. Chassis Cab DRW 2WD	6.8L V-10	18,400 (q/r)
F-550 Reg. Chassis Cab DRW 2WD	6.8L V-10	17,600 (q)
F-550 Reg. Chassis Cab DRW 2WD	6.4L V-8 TD	19,600 (q,t)
F-550 Reg. Chassis Cab DRW 4WD	6.8L V-10	18,100 (q/r)
F-550 Reg. Chassis Cab DRW 4WD	6.8L V-10	17,200 (q)
F-550 Reg. Chassis Cab DRW 4WD	6.4L V-8 TD	19,200 (q,t)

Manufacturer's note: Weights shown are for 141-inch wheelbase DRW models. For 165, 189 and 201-inch wheelbase models, weights may be somewhat less (200-400 pounds, depending on model).

F-350 Super Chassis Cab DRW 4WD	5.4L V-8	7,300 (i)
F-350 Super Chassis Cab DRW 4WD	5.4L V-8	9,800 (k)
F-350 Super Chassis Cab DRW 4WD	6.8L V-10	12,700 (k)
F-350 Super Chassis Cab DRW 4WD	6.8L V-10	14,700 (l)
F-350 Super Chassis Cab DRW 4WD	6.4L V-8 TD	14,900 (i/k)
F-450 Super Chassis Cab DRW 4WD	6.8L V-10	17,700 (q/r)
F-450 Super Chassis Cab DRW 4WD	6.4L V-8 TD	16,800 (l)
F-450 Super Chassis Cab DRW 4WD	6.4L V-8 TD	18,800 (q,t)
F-550 Super Chassis Cab DRW 4WD	6.8L V-10	17,700 (q/r)
F-550 Super Chassis Cab DRW 4WD	6.4L V-8 TD	16,800 (q/r)
F-350 Crew Chassis Cab DRW 4WD	5.4L V-8	7,100 (i)
F-350 Crew Chassis Cab DRW 4WD	5.4L V-8	9,600 (k)
F-350 Crew Chassis Cab DRW 4WD	6.8L V-10	12,500 (k)
F-350 Crew Chassis Cab DRW 4WD	6.8L V-10	14,500 (l)
F-350 Crew Chassis Cab DRW 4WD	6.4L V-8 TD	14,700 (i/k)
F-450 Crew Chassis Cab DRW 4WD	6.8L V-10	17,500 (q/r)
F-450 Crew Chassis Cab DRW 4WD	6.4L V-8 TD	16,700 (l)
F-450 Crew Chassis Cab DRW 4WD	6.4L V-8 TD	18,700 (q,t)
F-550 Crew Chassis Cab DRW 4WD	6.8L V-10	17,500 (q,r)
F-550 Crew Chassis Cab DRW 4WD	6.4L V-8 TD	16,600 (q)
F-550 Crew Chassis Cab DRW 4WD	6.4L V-8 TD	18,600 (q,t)

Manufacturer's note: Weights shown are for 176-inch wheelbase DRW models. For 200-inch wheelbase models, weights may be somewhat less (100-200 pounds, depending on model).

HONDA

Odyssey	3.5L V-6	3,500
Pilot 2WD	3.5L V-6	3,500
Pilot 4WD	3.5L V-6	4,500
Ridgeline	3.5L V-6	5,000

HUMMER

H2	6.2L V-8	8,200
H2 SUT	6.2L V-8	8,200
H3	3.7L I-5	4,500 (a)
H3	3.7L I-5	3,000 (m)
H3 Alpha	5.3L V-8	6,000
H3T	3.7L I-5	4,400 (a)
H3T	3.7L I-5	2,900 (m)
H3T Alpha	5.3L V-8	5,900

HYUNDAI

Santa Fe 2WD	TBD	TBD
Santa Fe 2WD	TBD	TBD
Santa Fe 4WD	TBD	TBD
Santa Fe 4WD	TBD	TBD
Tucson	TBD	TBD
Veracruz (All)	3.8L V-6	3,500 (t)

INFINITI

QX56 2WD	5.6L V-8	9,000
QX56 AWD	5.6L V-8	8,900
FX35 AWD	3.5L V-6	2,000
FX50	5.0L V-8	3,500

JEEP

Commander 2WD	3.7L V-6	3,500
Commander 2WD	5.7L V-8	7,400
Commander 4WD	3.7L V-6	3,500
Commander 4WD	5.7L V-8	7,200
Grand Cherokee 2WD	3.7L V-6	3,500
Grand Cherokee 4WD	3.7L V-6	3,500
Grand Cherokee 2WD	5.7L V-8	7,400
Grand Cherokee 4WD	5.7L V-8	7,200
Grand Cherokee SRT8	6.1L V-8	3,500
Liberty 2WD	3.7L V-6	5,000
Liberty 4WD	3.7L V-6	5,000
Patriot	2.4L I-4	2,000 (t)
Wrangler	3.8L V-6	2,000
Wrangler Unlimited	3.8L V-6	3,500
Wrangler Unlimited Rubicon	3.8L V-6	3,500

KIA

Borrego	3.8L V-6	5,000
Borrego	4.6L V-8	7,500
Sedona	3.8L V-6	3,500
Sportage	2.7L V-6	2,000

LAND ROVER

Land Rover LR2	3.2L I-6	3,500
Land Rover LR4	5.0L V-8	7,716
Range Rover	5.0L V-8	7,716
Range Rover Sport	All	7,716

LEXUS

RX 350	3.5L V-6	3,500
RX 400h (hybrid)	3.3L V-6	3,500
GX 470	4.7L V-8	6,500
LX 570	5.7L V-8	8,500

LINCOLN-MERCURY

Mariner	3.0L V-6	3,500 (t)
Mountaineer 2WD	4.0L V-6	3,500
Mountaineer 2WD	4.0L V-6	5,305 (t)
Mountaineer 4WD	All	3,500
Mountaineer 4WD	4.0L V-6	5,205 (t)
Mountaineer 2WD	4.6L V-8	7,115

Mountaineer AWD	All	3,500
Mountaineer AWD	4.0L V-6	5,000 (t)
Mountaineer AWD	4.6L V-8	7,040
MKT	All	2,000
MKT	All	4,500 (t)
MKX	All	2,000
MKX	All	3,500 (t)
Navigator 2WD	5.4L V-8	6,000
Navigator 2WD	5.4L V-8	9,200 (t)
Navigator L 2WD	5.4L V-8	6,000
Navigator L 2WD	5.4L V-8	8,700 (t)
Navigator 4WD	5.4L V-8	6,000
Navigator 4WD	5.4L V-8	8,700 (t)
Navigator L 4WD	5.4L V-8	6,000
Navigator L 4WD	5.4L V-8	8,500 (t)

MAZDA

CX7 (all)	2.3L I-4 TC	2,000
CX9 (all)	3.7L V-6	3,500
Tribute	3.0L V-6	3,500

MERCEDES-BENZ

G550	5.5L V-8	7,000
G55 AMG	5.4L V-8	7,000
GLK	3.5L V-6	3,500
GL320 BlueTEC	3.0L TD V-6	7,500
GL450	4.6L V-8	7,500
GL550	5.5L V-8	7,500
ML320 BlueTEC	3.0L TD V-6	7,200
ML350 2WD	3.5L V-6	4,600
ML350	3.5L V-6	7,200
ML450 Hybrid	3.5L V-6	5,000
ML550	5.5L V-8	7,200
ML63 AMG	6.3L V-8	7,200

MITSUBISHI

Outlander 2WD	3.0L V-6	2,000
Outlander 4WD	3.0L V-6	3,500
Endeavor	3.8L V-6	3,500

NISSAN

Armada 2WD	5.6L V-8	9,100
Armada 4WD	5.6L V-8	9,000
Frontier KC XE 2WD	2.5L I-4	3,500
Frontier KC SE, LE, Pro-4X 2WD	4.0L V-6	6,500
Frontier KC SE, LE, Pro-4X 4WD	4.0L V-6	6,300
Frontier CC SE, LE, Pro-4X 2WD	4.0L V-6	6,300
Frontier CC SE, LE, Pro-4X 4WD	4.0L V-6	6,100
Murano	3.5L V-6	3,500
Pathfinder	4.0L V-6	6,000
Pathfinder	5.6L V-8	7,000
Quest	3.5L V-6	3,500
Titan KC 2WD	5.6L V-8	9,500
Titan KC LB 2WD	5.6L V-8	9,400
Titan KC 4WD	5.6L V-8	9,400
Titan KC LB 4WD	5.6L V-8	9,200

Titan CC 2WD	5.6L V-8	9,400
Titan CC 4WD	5.6L V-8	9,400
Titan Long Bed CC 2WD	5.6L V-8	9,300
Titan Long Bed CC 4WD	5.6L V-8	9,100
Xterra	4.0L V-6	5,000

PORSCHE

Cayenne	All	7,716
---------	-----	-------

SAAB

9-3 (all)	All	3,500
-----------	-----	-------

SUBARU

Tribeca	3.6L H6	3500 (t)
Forester	2.5L H4	2,400
Outback	2.5L H4	2,700
Outback	3.6R H6	3,000

SUZUKI

Equator Extended Cab	2.5L I-4	3,500
Equator Extended Cab	4.0L V-6	6,500
Equator CC 2WD	4.0L V-6	6,300
Equator CC 4WD	4.0L V-6	6,100
Grand Vitara	2.4L I-4	3,000
Grand Vitara	3.2L V-6	3,000
XL7	3.6L V-6	3,500

TOYOTA

4Runner 2WD	2.7L I-4	2,000
4Runner 4WD	4.0L V-6	5,000
FJ Cruiser (all)	4.0L V-6	5,000
Highlander 4WD	2.7L I-4	3,500 (t)
Highlander 2WD/4WD	3.5L V-6	2,000
Highlander 2WD/4WD	3.5L V-6	5,000 (t)
Highlander Hybrid	3.3L V-6	3,500
Land Cruiser	5.7L V-8	8,500
RAV4 2WD/4WD	3.5L V-6	2,000
RAV4 2WD/4WD	3.5L V-6	3,500 (t)
Sienna	3.5L V-6	3,500
Sequoia 2WD SR5	4.6L V-8	7,300
Sequoia 4WD SR5	4.6L V-8	7,000
Sequoia 2WD SR5	5.7L V-8	8,300
Sequoia 2WD SR5	5.7L V-8	10,000 (t)
Sequoia 2WD Ltd	5.7L V-8	8,200
Sequoia 2WD Ltd	5.7L V-8	9,500 (t)
Sequoia 2WD Platinum	5.7L V-8	8,100
Sequoia 2WD Platinum	5.7L V-8	9,100 (t)
Sequoia 4WD SR5	5.7L V-8	8,000
Sequoia 4WD SR5	5.7L V-8	9,600 (t)
Sequoia 4WD Ltd	5.7L V-8	7,900
Sequoia 4WD Ltd	5.7L V-8	9,100 (t)
Sequoia 2WD Platinum	5.7L V-8	7,800
Sequoia 2WD Platinum	5.7L V-8	8,800 (t)
Tacoma Reg. Cab 2WD/4WD	2.7L I-4	3,500
Tacoma Access Cab/X-Runner 2WD/4WD	2.7L I-4	3,500
Tacoma Access Cab 2WD/4WD	4.0L V-6	5,000

Tacoma Access Cab 2WD/4WD	4.0L V-6	6,500 (t)
Tacoma Double Cab 2WD/4WD	4.0L V-6	5,000
Tacoma Double Cab 2WD/4WD	4.0L V-6	6,500 (t)
Tundra Reg. Cab SB	4.0L V-6	5,100
Tundra Reg. Cab LB 2WD	4.0L V-6	5,000
Tundra Double Cab SB 2WD	4.0L V-6	5,100
Tundra Double Cab LB 2WD	4.0L V-6	5,000
Tundra Reg. Cab SB 2WD	4.6L V-8	7,500
Tundra Reg. Cab SB 2WD	4.6L V-8	9,000 (t)
Tundra Reg. Cab SB 4WD	4.6L V-8	7,200
Tundra Reg. Cab SB 4WD	4.6L V-8	8,700 (t)
Tundra Reg. Cab LB 2WD	4.6L V-8	7,400
Tundra Reg. Cab LB 2WD	4.6L V-8	8,900 (t)
Tundra Reg. Cab LB 2WD	5.7L V-8	10,500 (t)
Tundra Reg. Cab LB 4WD	4.6L V-8	7,100
Tundra Reg. Cab LB 4WD	4.6L V-8	8,600 (t)
Tundra Reg. Cab LB 4WD	5.7L V-8	10,800 (t)
Tundra Double Cab SB 2WD	4.6L V-8	7,200
Tundra Double Cab SB 2WD	4.6L V-8	8,600 (t)
Tundra Double Cab SB 4WD	4.6L V-8	6,900
Tundra Double Cab SB 4WD	4.6L V-8	8,300 (t)
Tundra Double Cab Std. Bed 2WD	4.6L V-8	7,100
Tundra Double Cab Std. Bed 2WD	4.6L V-8	8,600 (t)
Tundra Double Cab LB 2WD	4.6L V-8	8,500
Tundra Double Cab Std. Bed 4WD	4.6L V-8	6,800

Tundra Double Cab Std. Bed 4WD	4.6L V-8	8,300 (t)
Tundra Double Cab LB 4WD	4.6L V-8	8,200
Tundra Reg. Cab 2WD	5.7L V-8	10,800
Tundra Reg. Cab 4WD	5.7L V-8	10,400
Tundra Double Cab 2WD	5.7L V-8	10,600
Tundra Double Cab 4WD	5.7L V-8	10,300
Tundra CrewMax 2WD	4.7L V-8	7,700 (t)
Tundra CrewMax 4WD	4.7L V-8	8,000 (t)
Tundra CrewMax 2WD	5.7L V-8	10,400
Tundra CrewMax 4WD	5.7L V-8	10,100

VOLKSWAGEN

Tiguan	2.0L I-4TC	2,200
Touareg	All	7,716

VOLVO

C30	2.5L I-5TC	2,000
S40	All	2,000
S80	All	3,300
V50	All	2,000
V70	3.2L I-6	3,300
XC60	All	3,300
XC70	All	3,300
XC90 FWD	3.2L V-6	3,970
XC90 AWD	4.4L V-8	4,960

A Smooth Air-Ride 5th Wheel Hitch in an easy to remove package

HENSLEY

Introducing!



BD3 5th Wheel Hitch

- Eliminates 97% of road shock
- Solid Holland-Binkley style head
- 1 1/8" thick jaws that completely encircle the kingpin
- Assembles in two pieces for easy installation and removal
- Fits standard rails



Call 1-800-410-6580 for more information

HENSLEY

800.410.6580 • www.TrailerSaver.com

Hensley Manufacturing Inc., go to www.trailerlife.com/info



HITCHING UP

Selecting and maintaining the proper hardware lead to a pleasant towing experience

BY JOEL DONALDSON

The process of buying a new travel trailer or fifth-wheel is full of choices. What is ultimately supposed to be an enjoyable experience is filled with such tasks as negotiating a price, arranging financing, settling on a fair trade-in value for your old rig and choosing insurance, floorplans, décor schemes and optional equipment. However, one of the most important choices may be considered an afterthought: namely, choosing the proper trailer hitch.

Fortunately, selecting the right hitch isn't difficult, nor is its installation — after locating a competent hitch shop, that is. Maintaining proper adjustment of the hitch on an ongoing basis is important, and it has a large bearing on the safety and enjoyment of trailer towing.

Trailers are available in two different designs — a travel trailer that's coupled to the rear of the tow vehicle by a conventional hitch ball, and a fifth-wheel trailer that utilizes a fifth-wheel (or gooseneck) hitch mounted in the truck bed, centered over the rear axle. The hitching methods are as different as the trailers and require specific knowledge by the installer and trailer owner.

28 | 2010 **TRAILER LIFE** Towing Guide

Weight Carrying

Class I	200-lb HW, 2,000-lb gvw
Class II	350-lb HW, 3,500-lb gvw
Class III	500-lb HW, 5,000-lb gvw
Class IV	750-lb HW, 7,500-lb gvw
Class V	1,200-lb HW, 12,000-lb gvw

Weight-Distributing

Class IV	1,200-lb HW, 12,000-lb gvw
Class V	1,400-lb HW, 14,000-lb gvw

HW=Hitch Weight

Conventional Hitches

All hitches are rated by their respective manufacturers to safely handle up to a specific gross vehicle weight (gvw), which is the weight of the trailer with full water and LP-gas cylinders — and all supplies aboard. Several weight classes exist for hitches designed for towing conventional travel trailers.

Weight-carrying hitches are intended for lighter trailers because the entire trailer's hitch weight is carried on the ball and transferred to the rear axle of the tow vehicle, whereas load-distributing hitches are designed to distribute



Previous page: New for 2011, Ford Super Duty trucks feature an optional factory-installed fifth-wheel hitch. The hitch is also covered by a factory warranty.

Left: To improve rear-view visibility and to aid in hitching up, Ford's available Reverse Camera System uses a camera mounted in the tailgate to produce a real-time visual display.

the trailer's hitch weight to all axles of the tow vehicle and trailer, making larger, heavier trailers with considerably higher hitch weights towable without destabilizing the tow vehicle.

A travel trailer with ideal weight distribution will have a minimum hitch weight of about 10 percent of the gross weight, and the maximum can range upward to 15 percent — providing it does not violate the rating of the hitch.

Except for the lightest folding trailers, hitch-rated Class II and higher are used for recre-



ational towing, and they use a receiver bolted to the tow vehicle's frame. The hitch receiver — which may have box dimensions of 1 1/4 inches square, 2 inches square or 2 1/2 inches square, with larger boxes for higher load ratings — accepts a slide-in ball mount (or draw bar), which is secured with a pin.

Besides serving as the trailer/receiver attachment point, the ball mount also is used in varying heights (known as “drop”) to couple the trailer in a level fashion (frame parallel to the road surface), which is desirable for best stability and trailer-brake performance. Some ball

mounts are fixed, while others are adjustable.

Ball mounts used for weight-carrying hitches are quite different than those used for load distributing. Need for weight-distributing hitches varies with tow-vehicle type and trailer weight. A trailer with 350 pounds of hitch weight may present no challenge for a stiffly sprung, long-wheelbase HD pickup, while it may destabilize a softly sprung compact SUV. In general, a weight-distributing hitch will im-

AL-KO Kober Corporation, (909) 591-5359, www.rbwindustries.com.

Automatic Equipment Manufacturing, (888) 425-5382, www.aemfg.com.

B&W Truck Beds Inc., (800) 248-6564, www.turnoverball.com.

Draw-Tite Hitches, (866) 308-9054, www.drawtite-hitches.com.

Equal-i-zer Hitch, (800) 478-5578, www.equalizerhitch.com.

Ford Motor Company, (800) 392-3673, www.ford.com.

Hensley Manufacturing, Inc., (800) 410-6580, www.hensleymfg.com.

MOR/ryde International, (574) 293-1581, www.morryde.com.

Pulliam Enterprises, (877) 785-5748, www.pullrite.com.

Reese Division, Cequent Towing Products, (800) 326-1090, www.reeseproducts.com.

Trailair, (800) 998-4238, www.trailair.com.

TrailerSaver Air Ride Hitches, (800) 410-6580, www.trailersaver.com.

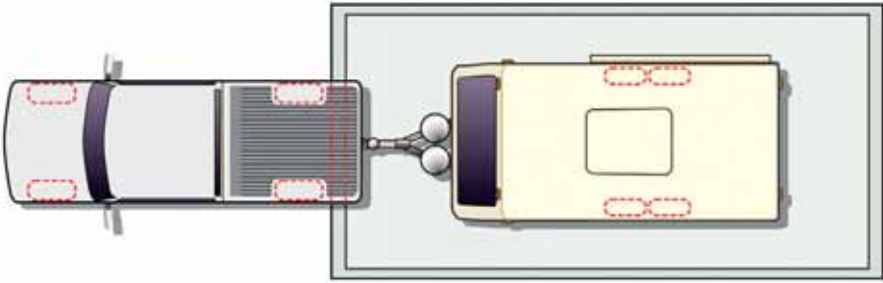

To determine the weight, first get a reading on axle weight (above), then unhitch the trailer for a total weight reading, and then subtract the two.

prove stability in most situations because weight resting on a hitch ball (when a weight-carrying hitch is used) loads the rear axle excessively by placing all of the hitch weight on that axle in addition to weight that is transferred from the front axle to the rear in a see-saw lever action.

Because many receivers are usable in either weight-carrying or weight-distributing configurations — depending on the ball mount — the receiver's manufacturer may list both ratings.

Weight-distributing hitches should be used in many weight situations of Class II, and in most situations of Class III and above. Unlike their weight-carrying counterparts, these hitches typically use a much heavier ball mount (that's adjustable in height), plus a pair of spring bars that provide the leverage needed to distribute weight fore and aft.

Adjusting the Hitch

After having a load-distributing hitch of proper weight rating installed, owners may take the rest for granted, which can be a costly error because an improperly adjusted load-distributing hitch can contribute to trailer sway, which is a very undesirable — and unsafe — handling trait.

The keys to happy towing are proper ball height and proper load (tension) on the spring bars. When all aspects are correct, the tow vehicle and the trailer are at proper ride height, which in most cases is level. One exception will be described later. Proper hitch adjustment helps prevent rear-axle overloading and improves braking and steering response.

Evaluating the proper adjustment of a load-distributing hitch is relatively simple: The tow vehicle should maintain the same attitude before hitching that it does after hitching, measured at reference points at the front and rear bumpers or wheel wells. If it is level before hitching, it should be level afterward, although slightly lower due to the addition of hitch weight. Level attitude means adequate load is placed on the



Hensley Cub

spring bars to distribute portions of the hitch weight equally to the front and rear axles. If the rear of the tow vehicle sags after hitching, then the spring-bar loading isn't adequate.

The exception to level attitude: If the tow vehicle is a stiffly sprung pickup and the rear of the truck is higher than the front, that attitude should be maintained after hitching. Such trucks often will carry heavy loads without the need for weight-distributing hitches and without sagging. But care must be exercised here. Although the truck may not look like it's sagging visually, the hitch weight carried by the rear axle may still create an unstable situation.

If the trailer is not level after spring bars have been adjusted to create the proper tow-vehicle attitude, the ball height should be corrected.

Trailer sway can be a problem if trailer balance or hitch adjustment are not correct because the trailer has steering leverage on the tow vehicle by virtue of being connected to the tow vehicle 3 or 4 feet behind the rear axle. With correct hitching, trailer balance may be a problem if the hitch weight is less than 10 percent of gross weight. It should be more than 10 percent (we recommend a minimum of 12 percent) for best stability.



Using a weight-carrying hitch



Using a weight-distributing hitch

A weight-distributing hitch distributes weight to all axles of the tow vehicle and the trailer.



Equal-i-zer Sway-Control Hitch



Draw-Tite W-D Hitch

Even with a well-balanced trailer and a properly adjusted hitch, use of a sway-control device is highly recommended. Often called sway bars (not to be confused with anti-roll bars fitted to axles of tow vehicles), sway-control devices are designed to damp rotation of the coupler on the hitch ball. They improve the handling characteristics of the trailer/tow vehicle combination whether the hitch method is weight-carrying or weight-distributing.

Sway-control devices are available in two different configurations, the most popular of which is one that employs a steel bar, attached to the ball mount, that is encased in a rail or tube attached to a small ball on the trailer A-frame. Inside the rail or tube is friction material that is clamped against the steel bar. Any pivoting of the trailer coupler on the bar causes the bar to slide within the rail, creating drag and damping sway. On larger trailers, it's often possible to use a pair of friction-type units for additional sway control.

One popular hitch, the Equal-i-zer, includes a friction feature in the hitch design in that the tips of spring bars create friction on trailer-frame brackets. Cam-type sway units work by modifying the operation of the spring bars on

a weight-distributing hitch. As the trailer turns, a cam increases the tension on one of the bars, creating a force that tends to pull the trailer back into a straight line. The harder the trailer turns, the stronger this self-centering force becomes. Since this scheme relies on spring-bar tension, it's generally most effective on trailers with relatively high hitch weights (e.g., trailers requiring considerable spring-bar tension).

The Hensley Arrow and Pulliam Enterprises' PullRite hitch systems offer different approaches to controlling sway.

The Hensley unit prevents sway through use of trapezoidal hitch linkages that make the tow vehicle and trailer act as a single unit, with no pivoting of the coupler on the ball unless the tow vehicle turns. Thus, during typical highway travel the tow vehicle and trailer are connected as non-articulated vehicles, and tend to function as a single unit. Even so, there is no restriction on the tow vehicle's capability for turns.

The PullRite, in effect, moves the hitch pivot point to a location immediately aft of the tow vehicle's rear axle, dramatically reducing the leverage the trailer can exert on the tow vehicle.

Fifth-Wheel Hitches

Fifth-wheel towing is a different story altogether. The trailer's kingpin serves as the pivot point for the fifth-wheel hitch, which is centered slightly ahead or above the truck's rear axle. The trailer's kingpin slides into the hitch saddle, where it is secured by latching jaws or some other mechanism. This saddle is attached to a support base, which transfers the towing forces to the truck frame.

The design prevents the trailer from having any steering effect on the tow vehicle, and is what gives fifth-wheel trailers such good road manners. Wind gusts and road irregularities have little to no effect on tow-vehicle stability.

Most hitches are secured to the bed with a pair of mounting rails, while other underbed

systems leave the truck bed flat after the hitch is removed.

Until now, fifth-wheel hitches have been strictly aftermarket add-ons. But Ford has upped the ante on the 2011 Ford Super Duty with the introduction of an industry-first factory-installed fifth-wheel (and goosneck) hitch, providing clean installation and a factory warranty. The trailer's electrical connection has been mounted into the side of the bed for added convenience.

Most removable aftermarket systems use permanently mounted rails with pins to secure the hitch saddle. The underbed style of fifth-wheel-hitch mount is completely different in



that the entire hitch mechanism is removed by simply pulling a lever in the wheel well. PullRite also uses an underbed system with removable connection pins. Some systems, where the hitch saddle and support base can be removed separately, make it easier on the back when lifting the hardware.

Many fifth-wheel hitches are mounted so they tilt fore and aft; however, having only the fore-and-aft pivot restricts side-to-side movement.

Some hitches have heads that pivot in multiple directions, allowing the pinbox to move in any direction with respect to the pickup, while still maintaining a tight mechanical connection. This also makes it easier to hitch or unhitch the trailer on uneven ground.

Another strategy for improving trailer-truck flexibility involves the use of air springs as part of the hitch design. Typically, the hitch is suspended on multiple bladder-type air bags, which support most of the trailer's kingpin weight. Aside from providing considerable articulation, these bags are also capable of smoothing out much of the road shocks and vibration that would otherwise be transmitted from the trailer to the tow vehicle. Adjustments to the system can be accomplished by varying

the amount of air pressure in the bags.

Other air-suspension hitches use a hinged pivot arm and a single airbag setup to provide truck-to-trailer impact damping while the hitch-saddle mechanism provides the side- and fore/aft head tilting.

Shortbed pickups are now more popular than ever, particularly among extended-cab models. However, a short bed often causes complications when using the truck for towing a fifth-wheel because the proper hitch-mounting location is far enough forward to cause trailer-to-cab collisions during sharp turns. Installing an extended pinbox provides a workable solution with smaller trailers with modest pin weights; however, owners should first check with the pinbox manufacturer before adding any extension.

One solution is a conventional hitch that can be manually unlocked and moved aft on a special set of rails before making tight turns. PullRite (SuperGlide) and Reese (Sidewinder) offer hitches that perform this motion automatically, returning to the forward-towing position after the turn is completed.



Rearward travel can be as much as 22 inches for some models, which is generally adequate for accommodating 102-inch-wide trailers. Turns as tight as 90 degrees are possible.

Maximum weight ratings for fifth-wheel hitches range up to 25,500 pounds gross weight, with as much as 25 percent of it on the hitch (most fivers have 20 percent hitch weight or less), and it's best to choose a unit that not only will handle the trailer it will be used to tow, but also any possibility of a larger trailer, although a higher-rated hitch will cost more and will be slightly heavier.

Whether while towing a conventional trailer or a fifth-wheel, the use of a properly rated hitch, adjusted correctly, will ensure a safe and pleasant towing experience. 🚛



TRAILER-BRAKE CONTROL

Technological advances help smooth out the process and improve safety and reliability

BY CHUCK HAMMOCK

Electric-brake systems have been employed for several decades on most trailers that have any significant weight. Each trailer with electric brakes, in turn, also requires that the tow vehicle be fitted with a brake controller.

For years, brake-controller choices have been extensive — all aftermarket and all electronic — but Ford changed the game in 2005 with the first trailer-brake-control (TBC) system included as an integral part of the design of the tow vehicle's design (GM and Dodge have since followed suit). The TBC synchronizes vehicle and trailer brakes for seamless braking (even under heavy load) to provide added driving control and confidence.

Until the advent of anti-lock brake systems (ABS), most brake controllers were tapped directly into the hydraulic lines of the tow vehicle's on-board hydraulic-braking system. They were often described as hydraulic/electric brake controllers, as they converted hydraulic pressure in the tow vehicle's brake system to an electric signal used to activate the trailer's brakes directly proportional to hydraulic

pressure in the vehicle's braking system.

A significant factor in elimination of this system was the advent of ABS because vehicle manufacturers' cautioned against tapping into the hydraulic system. The controllers displaced a small amount of brake fluid, and with ABS systems, brake-cylinder volume was more limited, so manufacturers warned not to add controllers that displaced more than 0.02 cubic inches. The tap-in could not occur downstream of the ABS mechanism, so the pressure was on to devise alternate systems.

Electronics were the answer, and many different types of aftermarket brake controllers were developed — none tied in with the tow vehicle's hydraulic system, however. Even in the old days of hydraulic/electric controllers, all were sold in the aftermarket, until Ford became the first to offer a trailer-brake actuation system installed at the factory.

Ford's TBC System

As Ford was first to offer a factory-installed brake controller into the tow vehicle, let's look at the system. Ford's integrated controller

2010 **TRAILER LIFE** Towing Guide | 33

electronically tracks hydraulic pressure inside the vehicle's master cylinder and uses the pressure, along with vehicle speed, to modulate the amount of current produced for trailer brakes. Thus, the system accurately follows tow-vehicle braking — more at high pedal pressure, less at low — even to the point of using ABS. If the wheels of the tow vehicle are slipping, ABS goes into action for the tow vehicle as well as the trailer. The Ford system doesn't give the trailer the same functions and characteristics of true ABS, but when the truck's ABS is activated, the trailer-brake application is reduced to avoid wheel lockup — just as with true ABS. A dash monitor indicates the level of trailer braking, and a manual override is provided so the trailer brakes can be applied independently of tow-vehicle brakes. TBC-equipped 2011 Ford Super Duty trucks also enjoy an added element of safety; if the trailer is swaying, the TBC will actually apply the trailer brakes to help stabilize the trailer.

The system cannot be retrofitted to earlier Ford models, and aftermarket controllers still must be used for most other vehicles, so the demand for those aftermarket controllers remains quite large. Accordingly, it's helpful to understand what's out there, and how to make a good choice.

In essence, all electronic brake controllers fall into two general categories: timer-based brake controllers and inertia-based proportional brake controllers. All brake controllers generate an output signal to a trailer-brake system when a user first touches the tow vehicle's brake pedal or activates the brake controller's manual control — if so equipped. What happens next varies greatly, depending on whether you're using a timer-based or proportional brake controller.

While most manufacturers will identify their proportional brake controllers as such, you usually won't see the words "timer-based" in the literature for a nonproportional brake controller. Instead, marketers will sometimes advertise timer-based controllers as having the advantage of requiring no leveling, but even that idea is confusing. Several proportional brake controllers do not require leveling. Timer-based controllers are also touted as being microprocessor-operated, but all brake controllers contain a processor of some kind. Even the most sophisticated timer-based microprocessor doesn't determine how hard you are braking, only how long you've been braking. A good rule of thumb is that if it doesn't say the word "proportional" somewhere in the literature, it's probably a timer-based brake controller.

34 | 2010 **TRAILER LIFE** Towing Guide

Timer-Based vs. Proportional

A timer-based brake controller has a timer that generates an output signal for your RV's brakes that increases with the amount of time you keep your foot on the brake pedal. It doesn't know whether you're braking gently on a gradual downhill grade, or if you're in a panic stop. The rate of increase in output (the slope of the voltage ramp) has no bearing on pedal effort, but can usually be adjusted for braking aggressiveness.

An inertia-based proportional controller generates an output that is, as the name suggests, directly proportional to your braking needs. Most proportional brake controllers



Hensley TruControl Gold



Tekonsha Prodigy P2

measure the tow vehicle's rate of deceleration by means of a pendulum. The quicker you slow, the farther the pendulum is displaced, via inertia, from its at-rest position. This creates an electric signal to your trailer's brakes that is proportional to your deceleration rate.

Tekonsha and its sister companies use a series of LEDs and photoelectric detectors in their proportional controllers to determine the position of the displaced pendulum, and therefore determine the deceleration rate. Hayes-Lemmerz uses the Hall effect, a physics principal involving moving magnets, to determine the pendulum's position.

All pendulum controllers are subject to some inaccuracies, as the pendulum can tilt slightly forward or backward on steep grades. Most such controllers employ a damping device to stabilize the sensor against vibrations, and

the damper helps reduce the effect of the fore-or-aft-tilt problem.

The pendulum's position is adjusted through the level-control knob, which allows the pendulum to be oriented to a true vertical resting position to compensate for the angle of the brake-controller body (the "leveling" referred to in some timer-based-controller advertising). The level adjustment also allows the driver to pitch the pendulum slightly forward or aft of its normal resting position to set up the trailer so its braking is aggressive or delayed.

Most drivers prefer some braking effect from the trailer's brakes on the initial touch of the brake pedal, and adjust the brake controller

moment. Keep in mind that a timer-based controller can't respond in this manner, as its output is fixed for a certain timed duration.

Among more recent developments, accelerometers are being used to measure braking force. Tekonsha has embraced this technology in its Prodigy brake control, and U.S. Gear uses it in the company's system intended for vehicles towed behind motorhomes. Hensley Manufacturing also uses accelerometers in its high-tech TruControl trailer brake control.

Aftermarket Installation

Critical to every successful brake-controller installation is the proper tow-vehicle wiring. While you should carefully follow the manufacturer's recommendations, there are certain common elements to almost every controller.

A reliable power source is a priority, which may include a vehicle manufacturer's built-in circuitry for an aftermarket brake controller. The main power line should be at least a 10 AWG wire from a circuit breaker at the fuse box, or the battery, to the brake controller's power-input connection (follow specific instructions for your controller). The circuit should continue from the controller, without any splices, and terminate at the seven-pin connector found at the rear of your tow vehicle. Most manufacturers advise against grounding the controller to the vehicle's firewall, but recommend routing a 10 AWG (or larger) separate ground wire directly to the battery; the controller may not function properly if the ground connection is not made directly to the battery terminal.

The other connection is made to the brake-light circuit, downstream of the brakelight switch mounted to the brake-pedal assembly, so the controller senses when the brakes have been activated.

Later-model vehicles with towing packages have brake-control wiring bundled under the dash with a plug-in connector attached. A pigtail with the mating part of the connector is supplied with the vehicle and is ready for connection to the brake-control wiring. This setup avoids most of the complexity and possible mistakes with locating the correct wiring among that maze under the dash.

Today's RVer has many choices in brake controllers from many manufacturers. It's important to carefully select the controller that is right for your needs and capable of handling the weight and number of axles on your trailer.

Be sure to follow the manufacturer's written instructions about every aspect of the brake controller's installation, operation, adjustment and maintenance for optimal performance. 🗨

2010 **TRAILER LIFE** Towing Guide | 35



accordingly to provide this so-called threshold voltage. This adjustment produces some output (typically 2 volts), without the initial time period having passed or deceleration having occurred in the two electric brake-controller types. This time period, or deceleration event, is normally needed to activate the timer-based controller or the proportional pendulum-based controller, respectively.

With dozens of different models of brake controllers on the market, many RVers may find the selection of the right controller difficult without some form of guidance. While budgetary considerations may force a user into one category of controller, this is a critical system where pinching pennies may not be advisable.

When faced with the need for a panic stop, most drivers want a controller that will respond in proportion to their braking needs at that

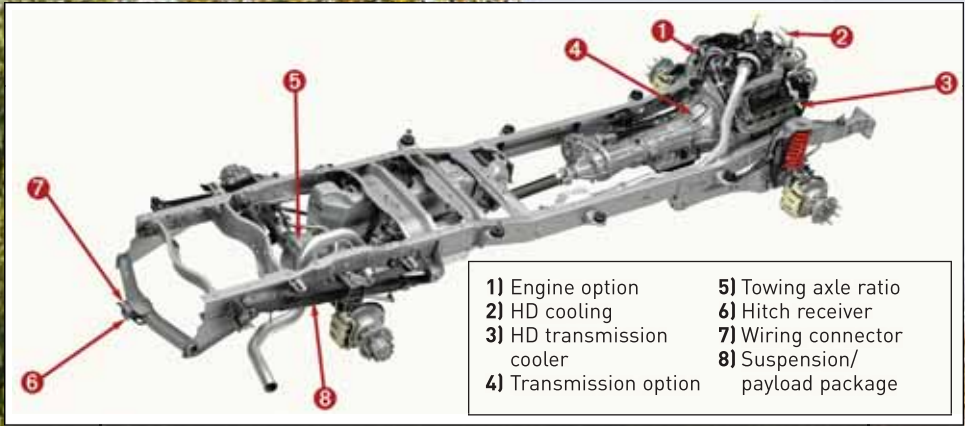

TOWING-PACKAGE COMPONENTS

Overall packages vary by model, but here are some components that may be included:

Hitch receiver
4- and/or 7-pin connector
Larger alternator
Larger battery
Larger radiator
Additional electric fan(s)
Transmission-fluid cooler
Engine-oil cooler

Rear anti-sway bar
Extendible mirrors
Vehicle Dynamic Control
Integrated brake controller
Brake controller (or unit pre-wire)
Synthetic lubricants
Lower axle ratio
Re-valved shock absorbers

WHAT'S IN A TOWING PACKAGE?

BY JEFF JOHNSTON

There are many bells and whistles available when choosing a new tow vehicle, but there's one option that is an absolute necessity: The towing package.

There are plenty of advantages to choosing factory-installed towing hardware. You have full

warranty coverage on the equipment. It was designed by the best engineering minds at a major auto manufacturer, which is reassuring when considering the hardware is tying your truck and trailer safely together. You'll probably save money over the cost of aftermarket hardware.



2010 **TRAILER LIFE** Towing Guide | 37



And perhaps best of all, use of the factory options means being ready for the road is a turnkey operation that calls for few or no trips to specialty shops after leaving the dealership.

In many cases, you don't have a choice. If the vehicle is to be rated for its highest towing capacity, the towing-package option is mandatory to give the tow vehicle its optimum performance potential. For less-strenuous duty, the towing package is optional.

Check the dealer literature to determine the content of the towing-package option. The following are some of the items you will likely encounter.

Axle Ratio: Most packages include a lower (numerically higher) axle ratio; for example, a 3.73:1 or 4.10:1 instead of the 3.55:1 that comes with the stock vehicle. A lower ratio results in greater torque multiplication at the rear wheels, which means more power for towing. It also means the engine turns somewhat faster for a given road speed, but that's the tradeoff for improved towing performance.

Hitch Receiver: If the tow vehicle already has a receiver, all you need to select is the proper ball mount and the associated hardware, such as a load-distributing hitch. The receiver will be properly matched to the tow vehicle's trailer-towing rating, so you needn't worry about any hitch-overloading situations — as long as you pay attention to the numbers. You'll also avoid interference problems with the exhaust pipe(s), the fuel tank and the spare tire.

Wiring Package: The wiring package is a group of color-coded pigtailed near the back

bumper that's ready for installation of the trailer-plug receptacle. It can be as complete as a plug or two installed out back, or a pre-wired pigtail for brake-control installation under the dash and full integration with the tow vehicle's electric system.

Alternator: It takes extra charging current to keep a trailer's battery(ies) charged in addition to handling the electrical-power needs of the tow vehicle. The battery itself may also be larger.

Heavy-Duty Suspension: The trailer and its hitch weight add load on the tow-vehicle suspension, so the normal reaction among dealership sales staff and buyers alike is to order the optional heavy-duty (HD) suspension, particularly when fifth-wheel towing is involved. In fact, when the trailer is a conventional ball-type trailer, it's often best not to order a heavy-spring option if there is a choice (if the towing package does not include HD suspension) for trucks rated 8,600 pounds and above because stiff ride and the tendency of the rear springs to do some or most of the work of the load-distributing hitch can be the result. A stiff ride is a very common complaint among owners of $\frac{3}{4}$ -ton and one-ton pickups not towing fifth-wheels.

A case can be made for not ordering an HD suspension even for fifth-wheel towing — except in very high pin-weight situations — opting instead to install auxiliary springs or air bags after delivery to support the pin weight (if necessary), which allows a more civilized ride on standard rear springs while not towing. It's necessary to compare the standard and optional rear-axle-weight ratings relative to the



Ford's folding mirrors offer a clear view of the side of the trailer when they're extended for towing, and require less space than conventional mirrors when folded.

original tow rig to offer a factory-installed brake controller, and GM and Dodge have since followed suit. Otherwise, towing packages usually include a trailer-wiring harness with a circuit for an aftermarket brake-control unit — a very worthwhile component of the package (see page 36).

Stability Control: More manufacturers are now offering electronic stability control. In addition, Ford's 2011 Super Duty trucks now include Trailer Sway Control (TSC), which can determine the yaw motion (sway) of the truck and take action, from applying precise braking to reducing engine torque.

Mirrors: Many towing packages offer mirrors designed to be extended outward while towing trailers.

Extra Cooling: The largest possible radiator, a larger transmission-oil cooler and often a power-steering-fluid cooler are essential parts of the usual HD cooling component of a towing package, and we advise that no tow vehicle should be ordered without them.

These components will not only help the tow vehicle avoid overheating any vital functional parts, but they will also lead to longer trouble-free component service life. 

anticipated trailer pin weight. It's easy to upgrade rear suspensions after a truck is built, but nearly impossible to soften the ride of an oversprung truck without replacing the suspension. SUVs have enough of their body weight on the rear axle, so that's generally not an issue.

Brake Control: Ford's Super Duty was the





READY FOR THE ROAD

Plenty of practice and defensive driving skills lead to safe and enjoyable towing

BY BRAD CLAYTON

Towing a trailer isn't very difficult, but it does represent a step up in complexity from driving a solo vehicle, requiring new awareness of combined vehicle length, trailer width, braking distance, turning characteristics and several other vital factors that must be considered while towing a trailer.

Most of us drive trucks, SUVs or passenger cars daily, and tow an RV only occasionally when vacationing. Thus, it's always necessary to make a mental transition and try to keep the size and handling characteristics of the larger rig in mind.

Allowing solo-vehicle habits to take over may result in a tendency to make turns too tightly, run over curbs, hit stationary objects such as overhanging tree limbs or to follow too closely.

Pay Attention

The first towing precautions are those that precede towing — matching the tow vehicle and trailer correctly, adhering to weight limits and making sure hitch selection and adjustment are correct, as described elsewhere in this guide. It's also important to refresh defensive driving skills. From there, the real fun begins.

The combined length of tow vehicle and trailer, as well as the combined weight, must



2010 **TRAILER LIFE** Towing Guide | 41

be in the forefront of your mind, right from the start. Maintaining extended following distances is one of the most important towing-related driving habits that initially is difficult to adhere to.

Even though trailer brakes may be functional, braking distances almost always are extended. It's also important to make lane changes carefully and slowly, and to allow extended distances for passing. High-quality, solidly mounted extendible mirrors with large reflective areas — adjusted properly — are also essential. Some manufacturers include factory-installed extendible mirrors, like those seen on Ford Super Duty trucks.

Speedy traffic seems more tolerant of slow 18-wheelers than of slow RVs, which makes courtesy an important safety factor for RV owners because an irate driver trying to pass can be a serious safety threat. Frequent monitoring of rearview mirrors is necessary while towing; when a vehicle is tailgating and trying to pass, we should help by driving slightly to the right to give the other driver a better view of the road ahead, even if a passing opportunity does not exist at the time. We should use turnouts whenever possible and avoid following another vehicle so closely that a vehicle overtaking from the rear cannot return to the proper lane.

Brake Time

While tow-vehicle and trailer brakes are adequate for most situations, care is necessary to avoid overheating, which can lead to brake fade. If brake fade occurs, it will likely be on steep downgrades. If this happens, friction will raise the temperature of brake pads and linings to extremely high levels, resulting in temporary loss of braking.

The cure is prevention, such as downshifting to a gear range that is low enough to retard speed sufficiently that brakes need not be used more than occasionally. This way, enough braking performance is reserved to make an emergency stop, should it become necessary.

When braking on a grade is necessary, apply the brakes intermittently, with moderate pressure, and release the pedal to allow the brakes to cool.

The action of electric trailer brakes should be apparent to the driver, and sufficient enough to handle the trailer's weight. The controller

should be adjusted so that maximum braking action does not cause trailer-wheel lockup. Improper controller adjustment is a major cause of inadequate braking, so it's wise to study the manufacturer's instructions. Travel-trailer instability (fishtailing) should not occur in a well-balanced, well-hitched combination, but if it does, independent actuation of trailer brakes usually will bring the trailer back into line.

When towing with a diesel, an aftermarket exhaust brake can be extremely beneficial. For 2011 Super Duty trucks, Ford offers fully integrated exhaust-brake control. There's no button to push; the diesel powertrain calibration automatically increases exhaust back pressure. Dodge also offers an integrated exhaust brake for 2011 Ram trucks with Cummins engines.

On the Right Track

All trailers require more space for turns, and travel trailers follow the tow-vehicle track more closely than do fifth-wheels, which track farther to the inside of a turn. There is need for continual awareness, which should eventually become second-nature after a modest amount of on-the-road experience.

Fifth-wheel trailers are different to back than conventional trailers, and require more practice for someone accustomed to backing a conventional trailer. A well-used technique involves placing one's hand at the bottom of the steering wheel and moving it in the same direction the trailer is intended to go. It's more effective with travel trailers than with fifth-wheels, which often require more turning of the steering wheel. Handheld two-way radios can allow an assistant to more effectively relay backing instructions to the driver.

Before each trip, it's essential to check the tires to assure that inflation pressures match those molded on tire sidewalls (cold), or that they are appropriate for your load (consult both the tire and vehicle load/inflation tables). Also, be sure to inspect all vehicle fluids, per standard maintenance procedure during heavy-duty vehicle use cycles, and make sure trailer-wheel lug nuts are tightened to factory specifications.

Trailer is a great way to explore the new horizons and a great way to check out the wonderful camping destinations that are available to owners of recreational trailers. And always keep in mind that defensive driving will pay off in safe travel. 🚚



Stop Fishtailing

Eliminate Trailer Sway

60 DAY
Money Back Guarantee
Lifetime Warranty

with the
Hensley Arrow® or
Hensley Cub
Anti-Sway
Towing System

Call 1-800-410-6580

Mention the Trailer Life Towing Guide
and receive a FREE Swift Hitch®
wireless back up camera or
NEW TruControl Gold II
Brake Controller*

HENSLEY

800.410.6580
www.HensleyMfg.com

*Offer Expires June 30th, 2010

Hensley Manufacturing Inc., go to www.trailerlife.com/info

Go To: **TRAILER**
LIFE.com

User Guide

Contents

YOUR CORPORATE LADDER

is right here.

Tailgate AND box side steps give you
amazingly easy access to payload.*



FORD F-150

FIND OUT MORE AT FORDVEHICLES.COM

Ford Motor Company, go to www.trailerlife.com/info

*Available box side and tailgate steps.



Welcome to our digital edition of Trailer Life Magazine. This format makes it easy for you to navigate the magazine and provides direct links to Internet sites of our advertisers, our TrailerLife.com Web site, and many Web sites to supplement our editorial features.

Here are some tips on how to use Digital Trailer Life:



- Click on the TrailerLife.com button to go directly to our Web site.
- Click on the User Guide button on any page to bring you back to this page.
- Click on the Contents button to take you to the Table of Contents page from anywhere in the magazine.

- When the hand icon changes to a pointing  finger, it indicates a link to a Web site or to another page in the magazine.

- Use the Zoom  tool to zoom in on the page. Use the Zoom-out tool  and hold down the option (Macintosh) or Windows key to toggle back and forth.

- Click and drag using the Dynamic Zoom  tool to infinitely control the zoom.

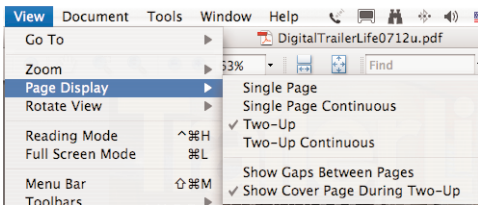

We recommend a Page Layout view of Two-Up (or Facing, depending on the version of Reader), Showing Cover Page, however, Adobe Reader provides several options you may prefer.

We hope you enjoy reading our Digital *Trailer Life* magazine, and we encourage your comments and suggestions to our editor at kbunker@affinitygroup.com